

2024 ESTATE
SUMMER

SINIS

IT +39 0221117815
IT +39 335 7600875
EN/FR +39 3425447140
ES +34 664 66 64 26
ES +34 664 66 64 28

SINEDITALIA.COM
SINEDITALIA.IT
SINEDITALIA.ES
POOL-SHOWERS.COM
DOCCIAPISCINA.IT
DUCHAEXTERIOR.ES

INFO@SINEDITALIA.COM

SIMBOLI *Symbols*



**IL DOPPIO DELLO SPES-
SORE. PIÙ RESISTENTE.**
*TWICE AS THICK. MORE
RESISTANT.*



**ACCESSORI IN OTTONE
BLACK MATT.**
*ACCESSORIES MADE OF
BRASS*



**INCLUDE UNA SACCA DI
PROTEZIONE**
*INCLUDES PROTECTIVE
BAG*

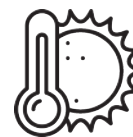

**DOCCIA
RISCALDAMENTO
SOLARE**
*SOLAR HEATING
SHOWER*



UGELLI ANTICALCARE
ANTI-SCALE NOZZLES



**CAPACITÀ DEL
SERBATOIO**
TANK CAPACITY



**ACQUA CALDA E
FREDDA**
HOT AND COLD WATER



**FILTRO ANTICALCARE
ESTERNO INCLUSO**
*EXTERNAL ANTI-SCALE
FILTER INCLUDED*



**PRODOTTO IN DUE PARTI.
SCATOLA FACILE DA
MANEGGIARE (-120CM)**
*PRODUCT IN TWO PARTS.
EASY TO HANDLE BOX
(-120CM)*

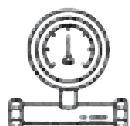

12 KGS
PRESSURE
**TUBI INTERNI
SILICONE FINO A 12
KG DI PRESSIONE**
*PIPE UP TO 12 KG OF
PRESSURE*

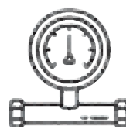

15 KGS
PRESSURE
**TUBI INTERNI BRAID
FINO A 15 KG DI
PRESSIONE**
*PIPE UP TO 15 KG OF
PRESSURE*

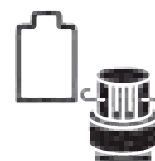

TAPPO DI DRENAGGIO
DRAINING PLUG

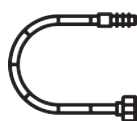

**COLLEGAMENTO ALL'AC-
QUA IN UN SOLO TUBO-**
*CONNECTION TO WATER IN
ONLY 1 PIPE*



**BOCCOLE IN NYLON RINFOR-
ZATO PER UN MIGLIORE
FISSAGGIO AL SUOLO**
*REINFORCED NYLON BUSHINGS
FOR BETTER GROUND FIXATION*



**VALVOLA DI INTERCETTA-
ZIONE DELL'ACQUA**
WATER SHUT-OFF VALVE



**PUÒ ESSERE
FACILMENTE
SMONTATA PER
L'INVERNO**
*CAN EASILY BE STORED AT
HOME IN THE WINTER*



**COLLEGAMENTO ACQUA
LATERALE 1/2"**
*SIDE WATER
CONNECTION*

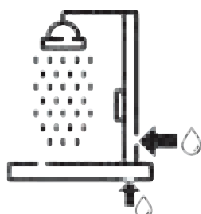

**COLLEGAMENTO ACQUA
LATERALE O
INFERIORE 1/2"**
*CONNECTION TO WATER
FROM THE SIDE OR FROM
BELOW*

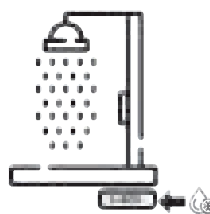

**COLLEGAMENTO ACQUA
NELLA PARTE
INFERIORE. C-BOX SOLO
ACQUA FREDDA**
*WATER CONNECTION AT
THE BOTTOM. COLD WATER
ONLY*

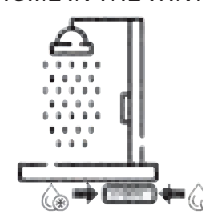

**COLLEGAMENTO ACQUA
NELLA PARTE
INFERIORE. C-BOX
ACQUA CALDA E
FREDDA**
*WATER CONNECTION AT
THE BOTTOM. HOT AND
COLD WATER*

DOCCE INOX ACCIAIO INOX

Le Docce Sined in Acciaio Inox 316L presentano un elegante Design innovativo e moderno e sono studiate anche per utilizzo in ambiente marino.

Sono Docce con speciale collegamento a terra tramite sistema di fissaggio speciale brevettato C-BOX con collegamenti per acqua calda e fredda. Le docce Sined Inox sono prodotte in due parti facilmente assemblabili per una movimentazione più rapida in una robusta confezione lunga solo 120 cm.

Ricambi e parti di ricambio sono pronti per essere spediti entro 24/48 dai magazzini in Italia. Sono facili da smontare e conservate al coperto in inverno. La Sacca protettiva è inclusa nella confezione.

Sined Stainless Steel 316L Showers feature an elegant innovative and modern Design and are also designed for use in marine environment.

They are Showers with special ground connection by special patented C-BOX fixing system with hot and cold water connections. Sined Inox showers are produced in two parts that can be easily assembled for faster handling in a sturdy package only 120 cm long.

Spare and replacement parts are ready to be shipped within 24/48 from warehouses in Italy. They are easily removable from the C-BOX and can be disassembled and stored indoors in winter. A protective bag is included in the package.

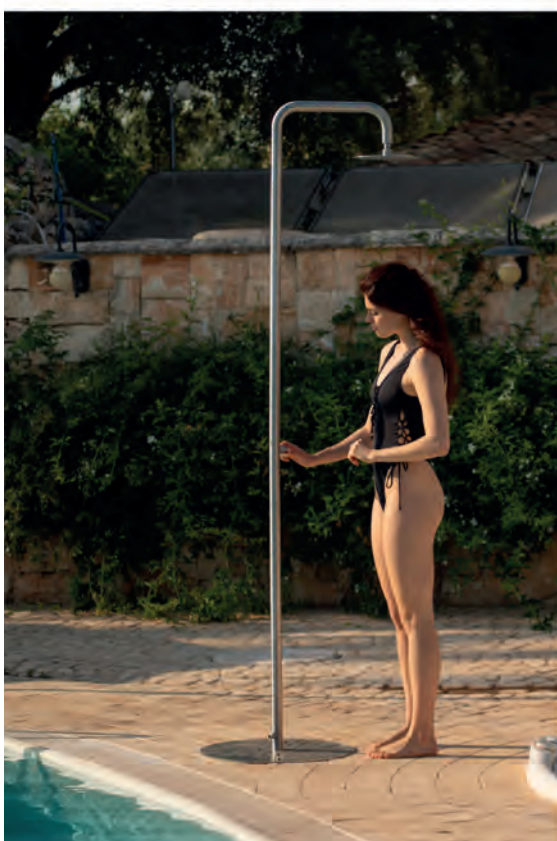

C-BOX PATENTED SYSTEM

CHE COS'È?



Nella confezione delle docce in acciaio Sined è compreso tutto il necessario per la loro installazione. L'esclusivo sistema C-BOX ti permetterà di assicurare la tua doccia collegandola direttamente all'impianto di casa, acqua calda e fredda. Tutto in modo facile e sicuro.

WHAT IS IT?

Included in the package of Sined steel showers is everything you need for their installation. The exclusive C-BOX system will allow you to secure your shower by connecting it directly to your home's hot and cold water system. All in an easy and safe way.



C-BOX

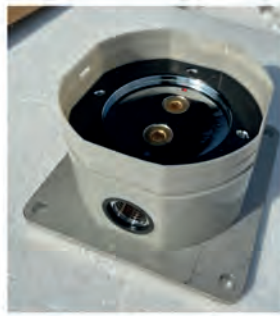

VITERIE E ATTREZZI IN ACCIAIO 316L



ATTACCO CON TRIPLO O-RING

Il C-Box consente una installazione perfetta, ed è protetto con un coperchio richiudibile per quando la doccia viene smontata. Il C-BOX deve essere installato perfettamente in bolla e fissato al suolo nel cemento con i 4 tasselli metallici in dotazione. All'interno del C-BOX troviamo gli innesti ad attacco rapido per collegare la doccia in acciaio. Gli attacchi rapidi posizionati alla base della doccia sono connessi con un triplo sistema di anelli OR a tenuta stagna. Anche tutti gli attrezzi in dotazione sono in acciaio

The C-Box allows perfect installation, and is protected with a lockable cover for when the shower is disassembled. The C-BOX must be installed perfectly level and fixed to the ground in concrete with the 4 metal plugs provided. Inside the C-BOX we find the quick-connect couplings to connect the steel shower. The couplings quick couplings located at the base of the shower are connected with a triple system of watertight OR rings. All of the supplied tools are also made of steel.

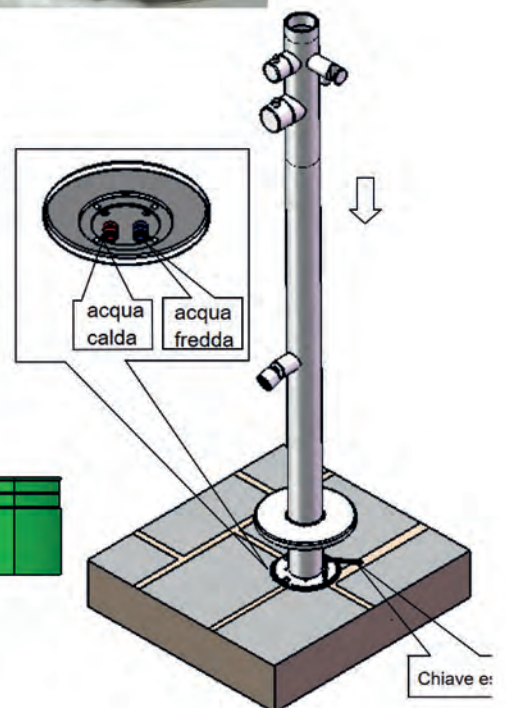
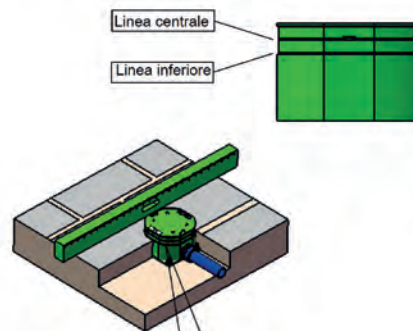
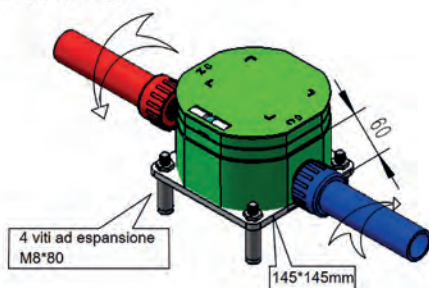

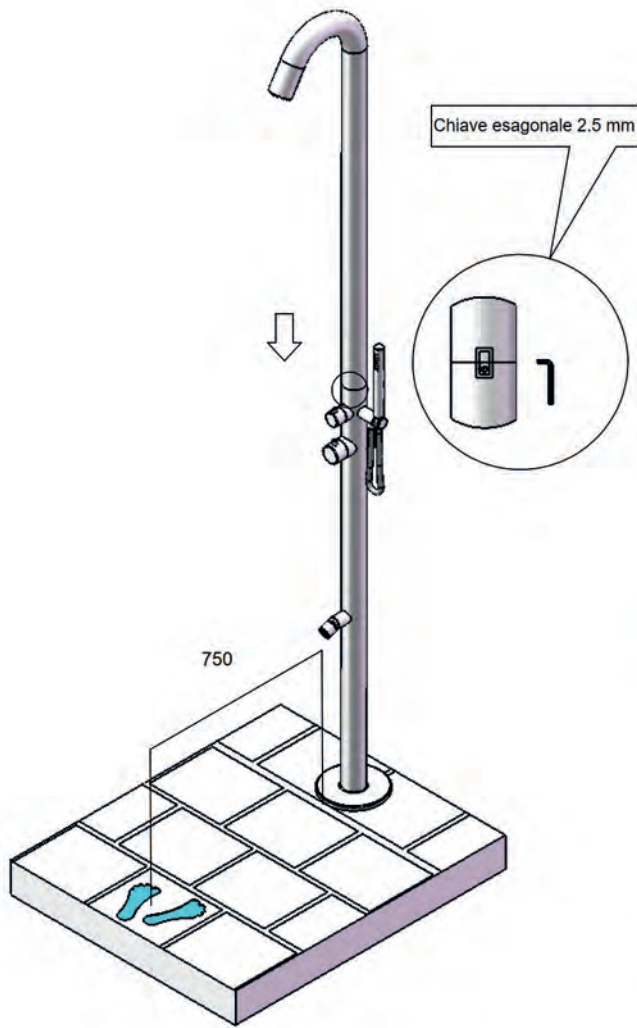

La C-BOX con i tubi dell'acqua calda e fredda è nascosta sotto il pavimento.



The C-BOX with the hot and cold water pipes are hidden under the floor.



**SOFFIONE IN ACCIAIO 316L
CON UGELLI IN SILICONE ANTICALCARE**

ALGHERO INOX

La doccia per esterno alta qualità in acciaio inox satinato con doccino per esterno modello ALGHERO SINED è una doccia in Acciaio Satinato Aisi Inox 316L con ingresso acqua calda e fredda H. 2289 mm. Ottima per Hotel, B e B, Campeggi, Stabilimenti Balneari, Bagno di casa, Terme.

- Doppio miscelatore a 3 vie, permette di avere acqua calda dal soffione e dalla doccetta a mano.
- Doccetta a mano
- Attacchi acqua a scomparsa sulla base.
- Rubinetteria in Acciaio Aisi 316L.
- Collegamento acqua dal basso con attacchi rapidi.
- Flessibile del doccino in acciaio inox AISI 304



DEUTSCH

Die Edelstahl-Außendusche mit Handbrause für den Außenbereich Modell ALGHERO SINED ist eine satinierte Edelstahl Dusche in Aisi Inox 316L mit Warm- und Kaltwasseranschluss, H. 2289 mm.

- Doppelter 3-Weg-Mischer, ermöglicht Warmwasser aus der Kopfbrause und aus der Handbrause.
- Handbrause
- Verdeckte Wasseranschlüsse an der Basis.
- Armaturen aus Edelstahl Aisi 316.
- Wasseranschluss von unten mit Schnellkupplungen.
- Handbrauseschlauch aus Edelstahl AISI 304

FRANÇAIS

ALGHERO SINED est une douche extérieure en acier inoxydable satiné de haute qualité avec douchette à main modèle ALGHERO SINED est un acier inoxydable satiné Aisi Inox 316L avec entrée d'eau chaude et froide H. 2289 mm.

- Double mélangeur à 3 voies, il permet d'avoir de l'eau chaude à partir de la tête de douche et de la douche à main.
- Douche à main
- Connexions d'eau dissimulées sur la base.
- Robinet en acier Aisi 316.
- Connexion d'eau par le bas avec des raccords rapides.
- Flexible de douche à main en acier inoxydable AISI 304

ENGLISH

ALGHERO SINED is a high quality satin stainless steel outdoor shower with hand shower for outdoor use model stainless steel Aisi Inox 316L with hot and cold water inlet, H. 2289 mm.

- Double 3 ways mixer, it allows to have hot water from the shower head and from the hand shower.
- Hand shower
- Concealed water connections on the base.
- Aisi 316 stainless steel taps.
- Water connection from the bottom with quick couplings.
- AISI 304 stainless steel hand shower hose

ESPAÑOL

El modelo ALGHERO SINED es una ducha de exterior de acero inoxidable satinado de alta calidad con ducha de mano para uso exterior. El modelo ALGHERO SINED es una ducha de acero inoxidable satinado Aisi Inox 316L con entrada de agua caliente y fría, H. 2289 mm.

- Mezclador doble de 3 vías, permite tener agua caliente desde el cabezal de la ducha y desde la ducha de mano.
- Ducha de mano
- Conexiones de agua ocultas en la base.
- Grifos de acero inoxidable Aisi 316.
- Conexión de agua desde la parte inferior con acoples rápidos.
- Manguera de ducha manual de acero inoxidable AISI 304

DOCCIA-ALGHERO-INOX

8025431016668



DIAGONAL
RAIN JET



ACQUA CALDA E
FREDDA
HOT AND COLD WATER



INCLUDE UNA SACCA
DI PROTEZIONE
INCLUDES PROTECTIVE
BAG



PUÒ ESSERE
FACILMENTE
SMONTATA PER
L'INVERNO
CAN EASILY BE STORED
AT HOME IN THE WINTER



PRODOTTO IN DUE PARTI.
SCATOLA FACILE DA
MANEGGIARE (-120CM)
PRODUCT IN TWO PARTS.
EASY TO HANDLE BOX
(-120CM)



UGELLI ANTICALCARE
ANTI-SCALE NOZZLES



SISTEMA
INSTALLAZIONE C-BOX
INCLUSO INCLUDED

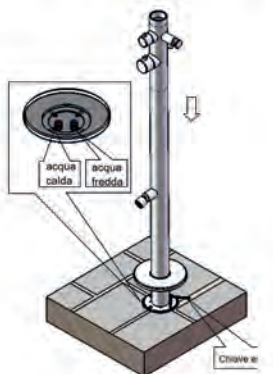
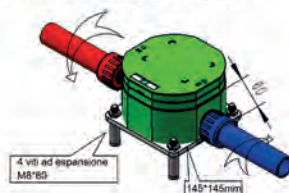

COLLEGAMENTO ACQUA NELLA
PARTE INFERIORE.
ACQUA CALDA E FREDDA.
WATER CONNECTION AT THE
BOTTOM.
HOT AND COLD WATER.

ACCIAIO
INOX 316L
NAUTICO NAUTICAL

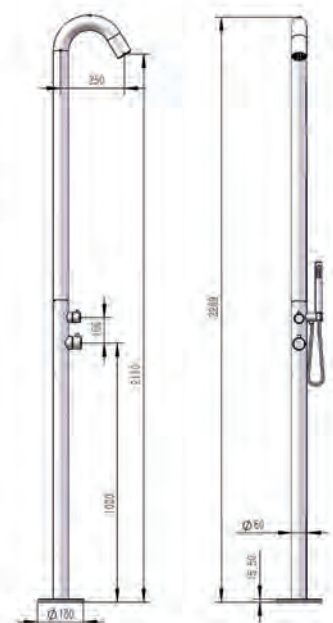

PESO

12,6 kg

COLORE

Inox satinato

COLLEGAMENTO

acqua calda - acqua fredda

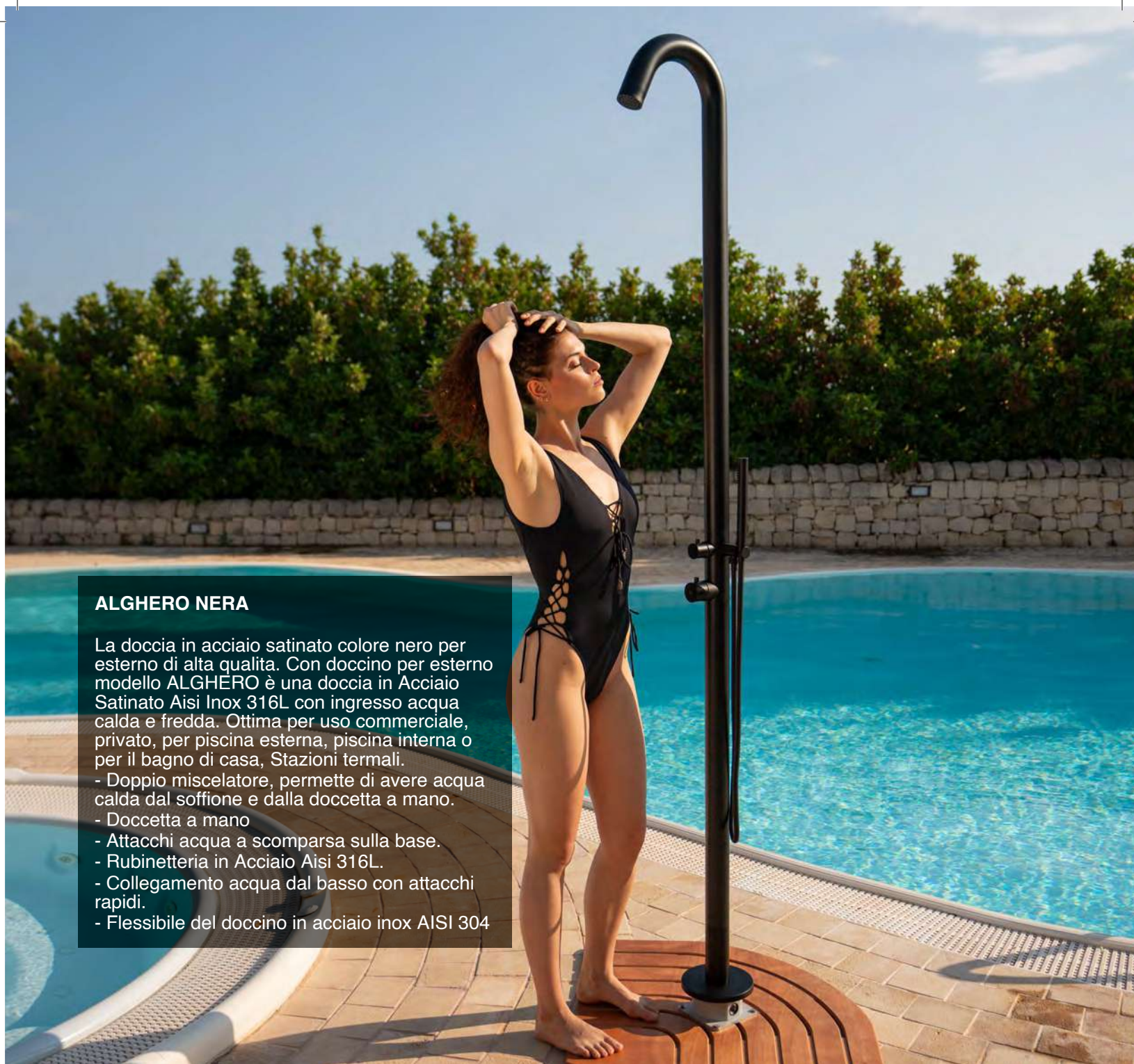

ALGHERO NERA

La doccia in acciaio satinato colore nero per esterno di alta qualità. Con doccino per esterno modello ALGHERO è una doccia in Acciaio Satinato Aisi Inox 316L con ingresso acqua calda e fredda. Ottima per uso commerciale, privato, per piscina esterna, piscina interna o per il bagno di casa, Stazioni termali.

- Doppio miscelatore, permette di avere acqua calda dal soffione e dalla doccetta a mano.
- Doccetta a mano
- Attacchi acqua a scomparsa sulla base.
- Rubinetteria in Acciaio Aisi 316L.
- Collegamento acqua dal basso con attacchi rapidi.
- Flessibile del doccino in acciaio inox AISI 304

DEUTSCH

Die hochwertige, schwarz satinierte Stahldusche für den Außenbereich. Das Modell ALGHERO mit Handbrause für den Außenbereich ist eine Dusche aus satiniertem Edelstahl Aisi Inox 316L mit Warm- und Kaltwasseranschluss.

- Doppelmischer, ermöglicht es, warmes Wasser von der Kopfbrause und von der Handbrause zu haben.
- Handbrause
- Verdeckte Wasseranschlüsse auf der Basis.
- Armaturen aus Edelstahl Aisi 316L.
- Wasseranschluss von unten mit Schnellkupplungen.
- Handbrauseschlauch aus Edelstahl AISI 304

FRANÇAIS

La douche en acier noir satiné de haute qualité pour une utilisation en extérieur. Avec douche à main pour l'extérieur modèle ALGHERO est une douche en acier inoxydable satiné Aisi Inox 316L avec entrée d'eau chaude et froide.

- Double mélangeur, permet d'avoir de l'eau chaude à partir de la tête de douche et de la douche à main.
- Douche à main
- Connexions d'eau dissimulées sur la base.
- Robinets en acier inoxydable Aisi 316L.
- Connexion d'eau par le bas avec des raccords rapides.
- Flexible de douche à main en acier inoxydable AISI 304

ENGLISH

The satin steel shower black color for outdoor high quality. With hand shower for outdoor model ALGHERO is a shower in Satin Steel Aisi Inox 316L with hot and cold water inlet.

- Double mixer, allows to have hot water from the shower head and from the hand shower.
- Hand shower
- Concealed water connections on the base.
- Aisi 316L stainless steel taps.
- Water connection from the bottom with quick couplings.
- AISI 304 stainless steel hand shower hose

ESPAÑOL

La ducha de acero negro satinado de alta calidad para uso exterior. Con ducha de mano para exteriores el modelo ALGHERO es una ducha en acero inoxidable satinado Aisi Inox 316L con entrada de agua caliente y fría. Excelente para uso comercial, privado, para piscina exterior, piscina interior o para el baño de casa, Spas.

- Mezclador doble, permite tener agua caliente desde el cabezal de la ducha y desde la teleducha.
- Ducha de mano
- Conexiones de agua ocultas en la base.
- Grifos de acero inoxidable Aisi 316L.
- Conexión de agua desde la parte inferior con acoples rápidos.
- Manguera de ducha manual de acero inoxidable AISI 304

DOCCIA-ALGHERO-NERA

8025431016675



DIAGONAL
RAIN JET



ACQUA CALDA E
FREDDA
HOT AND COLD WATER



INCLUDE UNA SACCA
DI PROTEZIONE
INCLUDES PROTECTIVE
BAG



PUÒ ESSERE
FACILMENTE
SMONTATA PER
L'INVERNO
CAN EASILY BE STORED
AT HOME IN THE WINTER



PRODOTTO IN DUE PARTI.
SCATOLA FACILE DA
MANEGGIARE (-120CM)
PRODUCT IN TWO PARTS.
EASY TO HANDLE BOX
(-120CM)



UGELLI ANTICALCARE
ANTI-SCALE NOZZLES



SISTEMA INSTALLAZIONE C-BOX INCLUSO INCLUDED

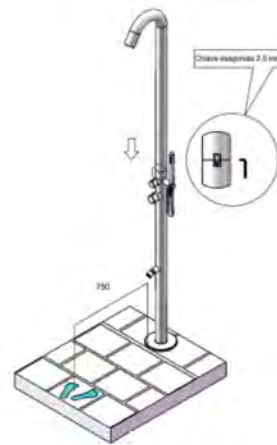
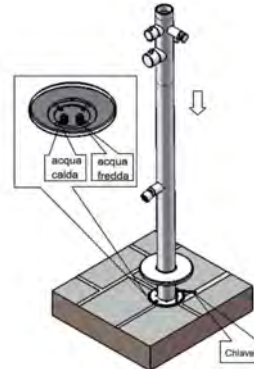
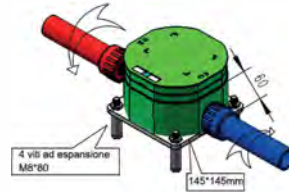

COLLEGAMENTO ACQUA NELLA
PARTE INFERIORE.
ACQUA CALDA E FREDDA.
WATER CONNECTION AT THE
BOTTOM.
HOT AND COLD WATER.

ACCIAIO
INOX 316L
NAUTICO NAUTICAL

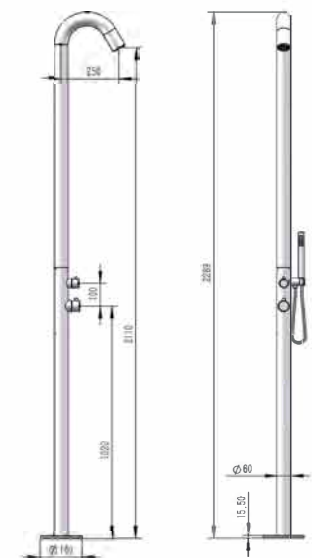

PESO
12,6 kg

COLORE
Nero satinato Matt Black

COLLEGAMENTO
acqua calda - acqua fredda

BOSA INOX

La doccia per piscina modello Bosa é una doccia in Acciaio Satinato Aisi Inox 316L con Fusto diametro 60 mm H 2289 mm.

Doppio ingresso acqua calda e Miselatore a 3 vie per Soffione, permette di avere acqua calda dal soffione, dalla doccetta a mano e dal lavapiedi.

Doccetta a mano e Lavapiedi.

Attacchi acqua a scomparsa sulla base.

Rubinetteria in Acciaio Aisi 316L.

Collegamento acqua dal basso con attacchi rapidi.

Flessibile del doccino in acciaio inox AISI 304.

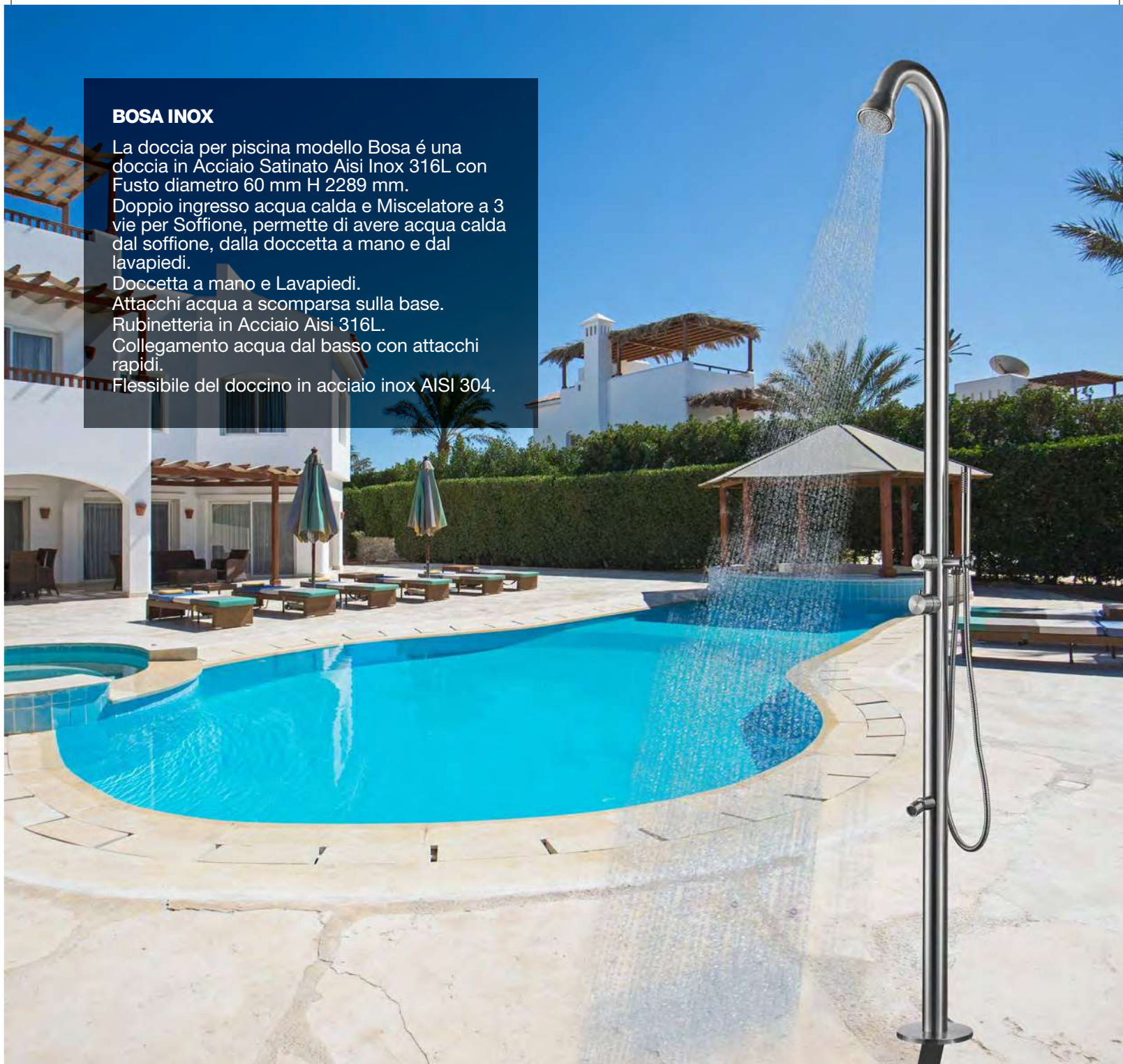

DEUTSCH

Die Pool-Dusche Modell Bosa ist eine Dusche aus satiniertem Edelstahl Aisi Inox 316L mit Warm- und Kaltwasserzulauf Schaft Durchmesser 60 mm H 2289 mm

3-Weg-Mischbatterie für die Kopfbrause, ermöglicht Warmwasser aus der Kopfbrause, aus der Handbrause und aus dem Fußwaschhahn.

Handbrause und Fußwaschhahn Verdeckte Wasseranschlüsse an der Basis.

Armaturen aus Stahl Aisi 316L. Wasseranschluss von unten mit Schnellkupplungen.

Rostfreier Stahl AISI 316L, mobiler Brauseschlauch AISI 304

FRANÇAIS

La douche de piscine modèle Bosa est une douche en acier inoxydable satiné Aisi Inox 316L avec diamètre de l'arbre 60 mm H 2289 mm

Double entrée d'eau chaude et froide Mélangeur 3 voies pour la tête de douche, permet d'avoir de l'eau chaude de la tête de douche, de la douchette à main et du lave-pieds.

Raccordement d'eau encastré sur la base.

Raccords en acier Aisi 316L. Raccordement de l'eau par le bas avec des raccords rapides. Acier inoxydable AISI 316L, tuyau de douche mobile AISI 304.

ENGLISH

The pool shower model Bosa is a shower in Satin Stainless Steel Aisi Inox 316L with hot and cold water inlet Drum diameter 60 mm H 2289 mm

3-way mixer for shower head, allows to have hot water from the shower head, from the hand shower and from the foot wash. Hand shower and foot wash. Concealed water connections on the base.

Fittings in Aisi 316L stainless steel. Water connection from the bottom with quick couplings. Stainless steel AISI 316L, mobile shower hose AISI 304.

ESPAÑOL

La ducha de piscina modelo Bosa es una ducha en Acero Inoxidable Satinado Aisi Inox 316L con entrada de agua caliente y fría Estructura de diámetro 60 mm H 2289 mm

Mezclador de 3 vías para el cabezal de ducha, permite tener agua caliente del cabezal de ducha, de la teleducha y del lavapiés.

Ducha de mano y lavapiés. Conexiones de agua ocultas en la base.

Accesorios de acero Aisi 316L. Conexión de agua por la parte inferior con acoples rápidos. Acero inoxidable AISI 316L, manguera de ducha móvil AISI 304.

DOCCIA-BOSA-INOX

8025431016682



DIAGONAL
RAIN JET



ACQUA CALDA E
FREDDA
HOT AND COLD WATER



INCLUDE UNA SACCA
DI PROTEZIONE
INCLUDES PROTECTIVE
BAG



PUÒ ESSERE
FACILMENTE
SMONTATA PER
L'INVERNO
CAN EASILY BE STORED
AT HOME IN THE WINTER



PRODOTTO IN DUE PARTI.
SCATOLA FACILE DA
MANEGGIARE (-120CM)
PRODUCT IN TWO PARTS.
EASY TO HANDLE BOX
(-120CM)



UGELLI ANTICALCARE
ANTI-SCALE NOZZLES



SISTEMA
INSTALLAZIONE C-BOX
INCLUSO INCLUDED

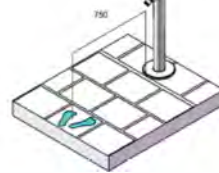
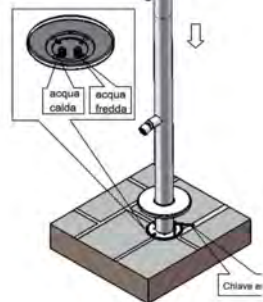
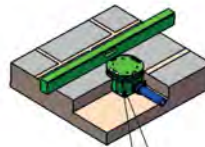
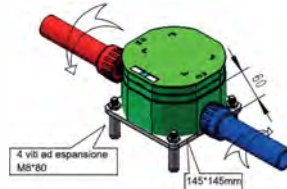

COLLEGAMENTO ACQUA NELLA
PARTE INFERIORE.
ACQUA CALDA E FREDDA.
WATER CONNECTION AT THE
BOTTOM.
HOT AND COLD WATER.

PESO
14 kg

COLORE
Inox satinato

COLLEGAMENTO
acqua calda - acqua fredda

ACCIAIO
INOX 316L
NAUTICO NAUTICAL

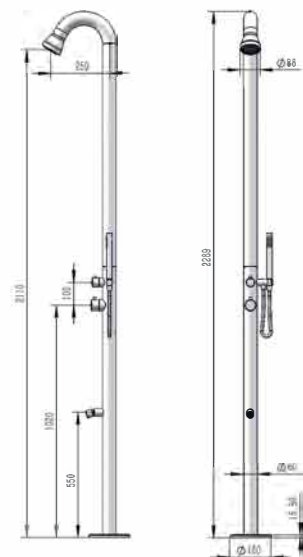
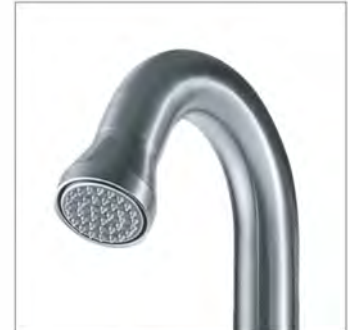



BOSA NERA

La doccia per esterno nera alta qualità per piscina modello Bosa è una doccia in Acciaio Satinato Aisi Inox 316L con ingresso acqua calda e fredda Fusto diametro 60 mm.

- Miscelatore a 3 vie per Soffione, permette di avere acqua calda dal soffione, dalla doccetta a mano e dal lavapiedi.
- Doccetta a mano e Lavapiedi
- Attacchi acqua a scomparsa sulla base.
- Rubinetteria in Acciaio Aisi 316L.
- Collegamento acqua dal basso con attacchi rapidi.
- Flessibile del doccino in acciaio inox AISI 304

DEUTSCH

Die hochwertige schwarze Außendusche für Schwimmbad Modell Bosa ist eine Dusche in Satin-Finish Aisi Inox 316L mit Warm- und Kaltwassereinlass 60 mm Durchmesser Welle

- 3-Weg-Mischer für Duschkopf, ermöglicht heißes Wasser von der Kopfbrause, von der Handbrause und vom Fußwaschhahn zu haben.
- Handbrause und Fußwaschhahn
- Verdeckte Wasseranschlüsse am Boden
- Armaturen aus Edelstahl Aisi 316L
- Wasseranschluss von unten mit Schnellkupplungen.
- Handbrauseschlauch aus Edelstahl AISI 304

FRANÇAIS

Le modèle Bosa est une douche extérieure noire pour piscine de haute qualité en acier inoxydable Aisi Inox 316L satiné avec arrivée d'eau chaude et froide. Arbre de 60 mm de diamètre

- Mélangeur 3 voies pour la pomme de douche, il permet d'avoir de l'eau chaude de la pomme de douche, de la douchette et du lave-pieds.
- Douche à main et lave-pieds
- Raccordements d'eau dissimulés sur la base
- Robinetterie en acier inoxydable Aisi 316L.
- Raccordement d'eau par le bas avec raccords rapides.
- Flexible de douche à main en acier inoxydable AISI 304

ENGLISH

The high quality black outdoor shower for swimming pool model Bosa is a shower in Satin-finish Aisi Inox 316L with hot and cold water inlet 60 mm diameter shaft

- 3 way mixer for shower head, allows to have hot water from the shower head, from the hand shower and from the foot wash.
- Hand shower and foot wash
- Concealed water connections on the base
- Aisi 316L stainless steel taps
- Water connection from the bottom with quick couplings.
- AISI 304 stainless steel hand shower hose

ESPAÑOL

La ducha de exterior de alta calidad de color negro para piscina modelo Bosa es una ducha en Acabado satinado Aisi Inox 316L con entrada de agua caliente y fría de 60 mm de diámetro

- Mezclador de 3 vías para el cabezal de ducha, permite tener agua caliente del cabezal de ducha, de la teleducha y del lavapiés.
- Ducha de mano y lavapiés
- Conexiones de agua ocultas en la base
- Grifería de acero inoxidable Aisi 316L
- Conexión de agua desde abajo con acoples rápidos.
- Manguera de ducha manual de acero inoxidable AISI 304

DOCCIA-BOSA-NERA

8025431016699



DIAGONAL
RAIN JET



ACQUA CALDA E
FREDDA
HOT AND COLD WATER



INCLUDE UNA SACCA
DI PROTEZIONE
INCLUDES PROTECTIVE
BAG



PUÒ ESSERE
FACILMENTE
SMONTATA PER
L'INVERNO
CAN EASILY BE STORED
AT HOME IN THE WINTER



PRODOTTO IN DUE PARTI.
SCATOLA FACILE DA
MANEGGIARE (-120CM)
PRODUCT IN TWO PARTS.
EASY TO HANDLE BOX
(-120CM)



UGELLI ANTICALCARE
ANTI-SCALE NOZZLES



SISTEMA
INSTALLAZIONE C-BOX
INCLUSO INCLUDED

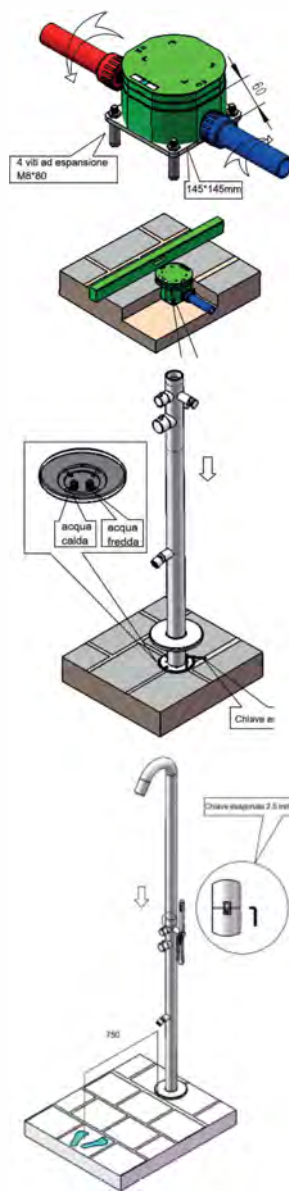

COLLEGAMENTO ACQUA NELLA
PARTE INFERIORE.
ACQUA CALDA E FREDDA.
WATER CONNECTION AT THE
BOTTOM.
HOT AND COLD WATER.

PESO
14 kg

COLORE
Inox satinato

COLLEGAMENTO
acqua calda - acqua fredda

ACCIAIO
INOX 316L
NAUTICO NAUTICAL

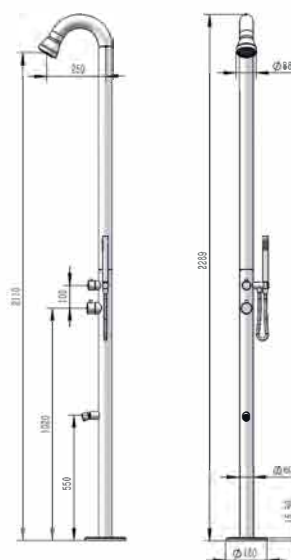

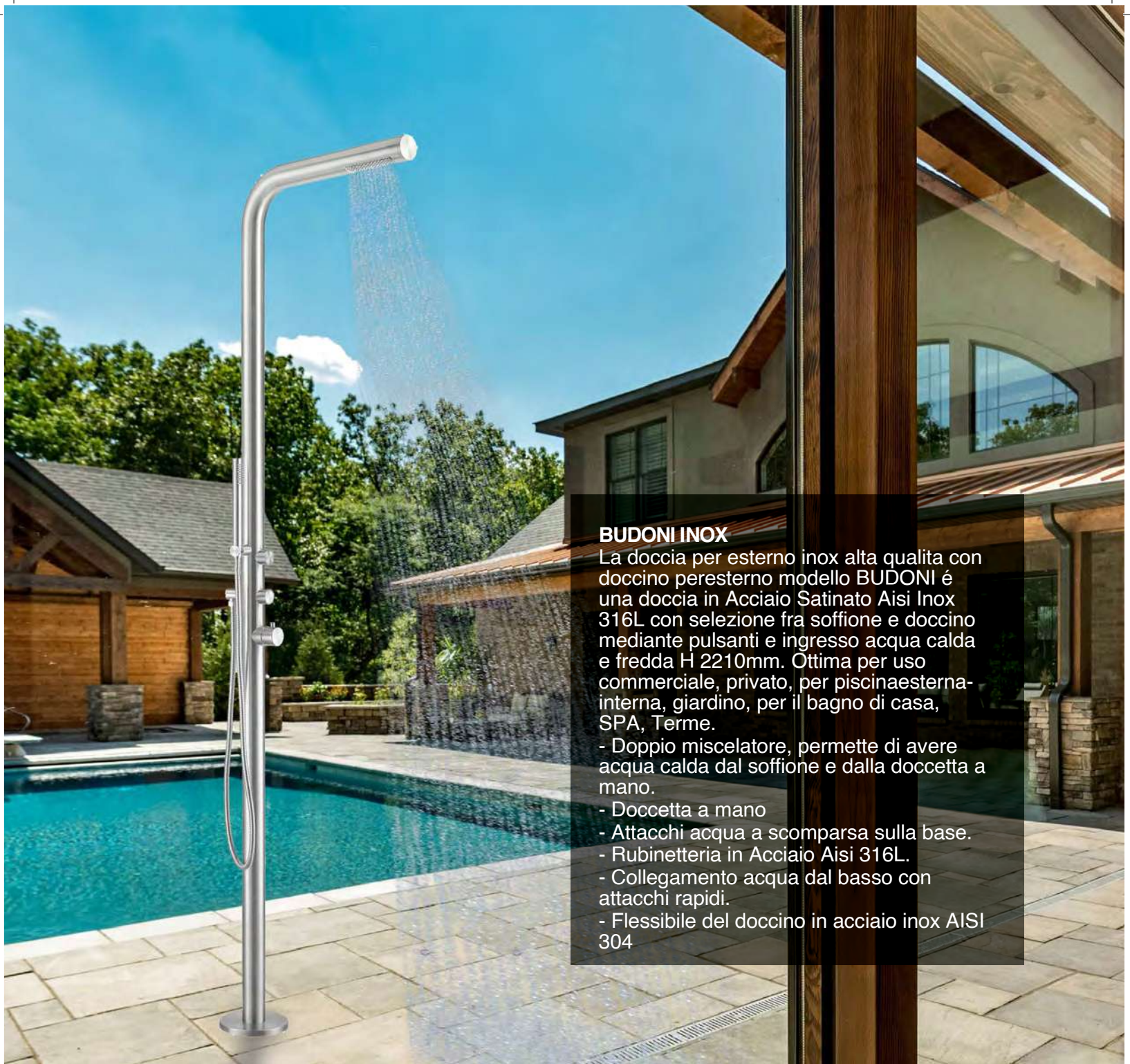

BUDONI INOX

La doccia per esterno inox alta qualità con doccino per esterno modello BUDONI è una doccia in Acciaio Satinato Aisi Inox 316L con selezione fra soffione e doccino mediante pulsanti e ingresso acqua calda e fredda H 2210mm. Ottima per uso commerciale, privato, per piscina esterna-interna, giardino, per il bagno di casa, SPA, Terme.

- Doppio miscelatore, permette di avere acqua calda dal soffione e dalla doccetta a mano.
- Doccetta a mano
- Attacchi acqua a scomparsa sulla base.
- Rubinetteria in Acciaio Aisi 316L.
- Collegamento acqua dal basso con attacchi rapidi.
- Flessibile del doccino in acciaio inox AISI 304

DEUTSCH

Die hochwertige Edelstahl-Außendusche Modell BUDONI mit Handbrause für den Außenbereich ist eine Dusche aus satiniertem Edelstahl Aisi Inox 316L mit Warm- und Kaltwasseranschluss H 2210 mm.

- Doppelmischbatterie, sie ermöglicht es, warmes Wasser von der Kopfbrause und von der Handbrause zu haben.
- Handbrause
- Verdeckte Wasseranschlüsse an der Basis
- Armaturen aus rostfreiem Stahl Aisi 316L
- Wasseranschluss von unten mit Schnellkupplungen
- Handbrauseschlauch aus Edelstahl AISI 304

FRANÇAIS

La douche extérieure en acier inoxydable de haute qualité. Avec douche à main pour l'extérieur modèle BUDONI est une douche en acier inoxydable Aisi Inox 316L avec entrée d'eau chaude et froide H 2210 mm.

- Double mélangeur, il permet d'avoir de l'eau chaude à partir de la pomme de douche et de la douchette à main.
- Douche à main
- Raccordements d'eau dissimulés sur la base.
- Robinets en acier inoxydable Aisi 316L.
- Raccordement d'eau par le bas avec des raccords rapides.
- Flexible de douche à main en acier inoxydable AISI 304

ENGLISH

The shower for outdoor high quality stainless steel. With shower for external model BUDONI is a shower in steel Satin Aisi Inox 316L with hot and cold water inlet H 2210 mm.

- Double mixer, it allows to have hot water from the shower head and from the hand shower.
- Hand shower
- Concealed water connections on the base.
- Aisi 316L stainless steel taps.
- Water connection from the bottom with quick couplings.
- AISI 304 stainless steel hand shower hose

ESPAÑOL

La ducha exterior de acero inoxidable de alta calidad. Con ducha de mano para exteriores el modelo BUDONI es una ducha en acero inoxidable satinado Aisi Inox 316L con entrada de agua caliente y fría H 2210 mm.

- Mezclador doble, permite tener agua caliente desde el cabezal de la ducha y desde la ducha de mano.
- Ducha de mano
- Conexiones de agua ocultas en la base.
- Grifos de acero inoxidable Aisi 316L.
- Conexión de agua por la parte inferior con acoples rápidos.
- Manguera de ducha manual de acero inoxidable AISI 304

DOCCIA-BUDONI-INOX

8025431016705

ACCIAIO
INOX 316L
NAUTICO NAUTICAL



VERTICAL
RAIN JET



ACQUA CALDA E
FREDDA
HOT AND COLD WATER



INCLUDE UNA SACCA
DI PROTEZIONE
INCLUDES PROTECTIVE
BAG



PUÒ ESSERE
FACILMENTE
SMONTATA PER
L'INVERNO
CAN EASILY BE STORED
AT HOME IN THE WINTER



PRODOTTO IN DUE PARTI.
SCATOLA FACILE DA
MANEGGIARE (-120CM)
PRODUCT IN TWO PARTS.
EASY TO HANDLE BOX
(-120CM)



UGELLI ANTICALCARE
ANTI-SCALE NOZZLES



SISTEMA
INSTALLAZIONE C-BOX
INCLUSO INCLUDED

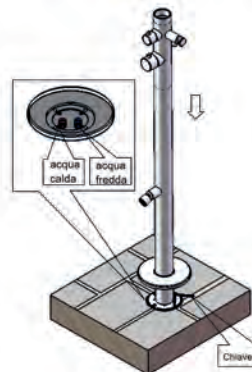
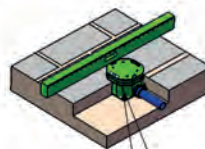
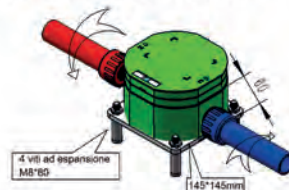

COLLEGAMENTO ACQUA NELLA
PARTE INFERIORE.
ACQUA CALDA E FREDDA.
WATER CONNECTION AT THE
BOTTOM.
HOT AND COLD WATER.

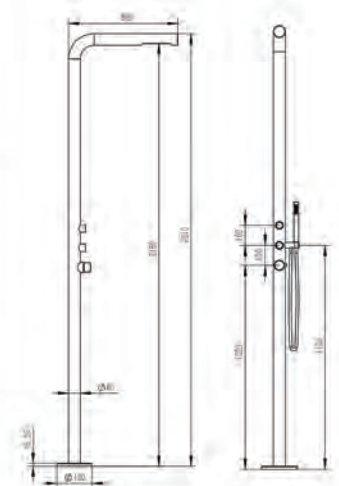

PESO
10,3 Kg

COLORE
Inox satinato

COLLEGAMENTO
acqua calda - acqua fredda

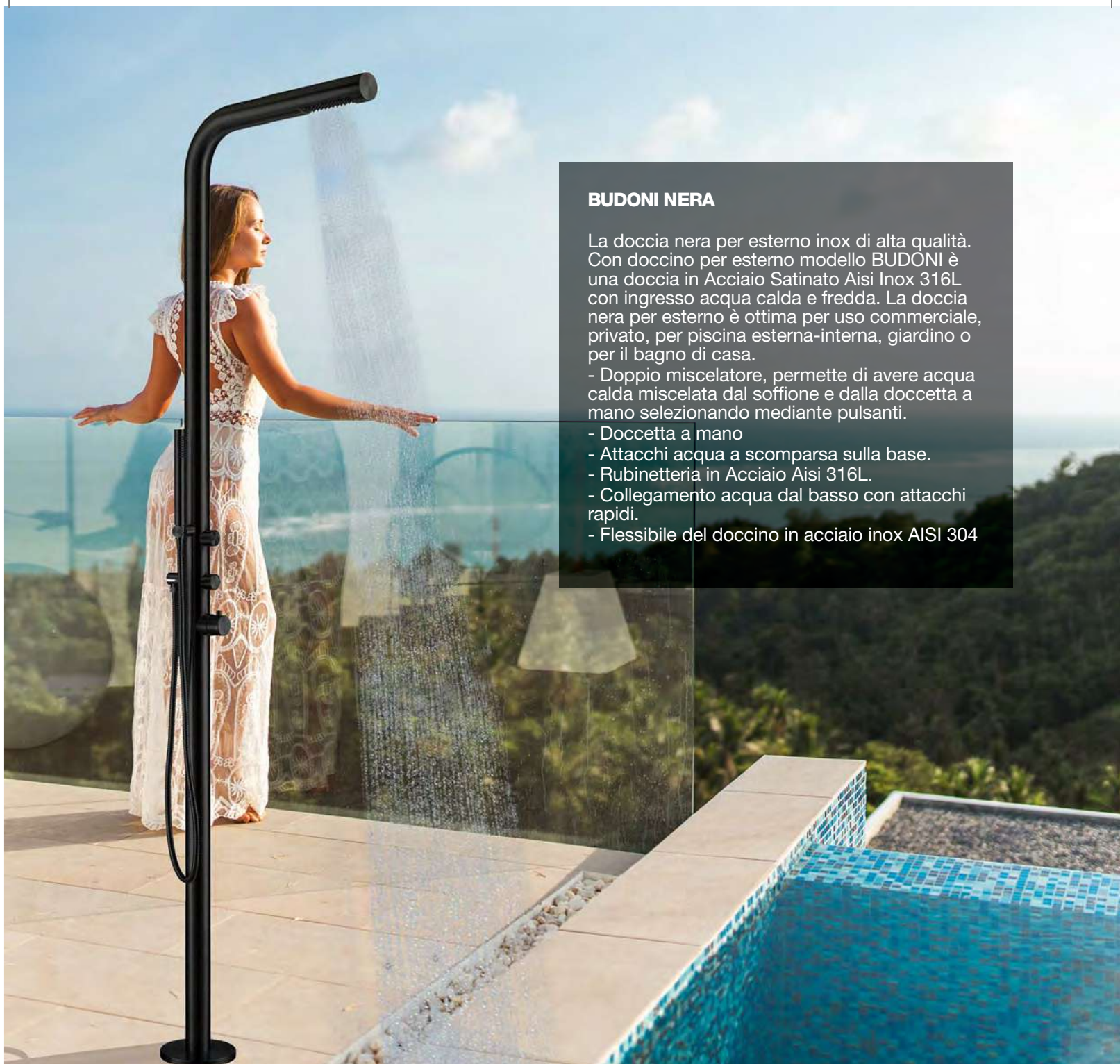

BUDONI NERA

La doccia nera per esterno inox di alta qualità. Con doccino per esterno modello BUDONI è una doccia in Acciaio Satinato Aisi Inox 316L con ingresso acqua calda e fredda. La doccia nera per esterno è ottima per uso commerciale, privato, per piscina esterna-interna, giardino o per il bagno di casa.

- Doppio miscelatore, permette di avere acqua calda miscelata dal soffione e dalla doccetta a mano selezionando mediante pulsanti.
- Doccetta a mano
- Attacchi acqua a scomparsa sulla base.
- Rubinetteria in Acciaio Aisi 316L.
- Collegamento acqua dal basso con attacchi rapidi.
- Flessibile del doccino in acciaio inox AISI 304

DEUTSCH

Die hochwertige schwarze Edelstahl-Außendusche Modell BUDONI mit Handbrause für den Außenbereich ist eine Dusche aus satiniertem Edelstahl Aisi Inox 316L mit Warm- und Kaltwasseranschluss.

- Doppelmischbatterie, die es ermöglicht, warmes Wasser von der Kopfbrause und von der Handbrause zu haben.
- Handbrause
- Verdeckte Wasseranschlüsse an der Basis.
- Armaturen aus Edelstahl Aisi 316L.
- Wasseranschluss von unten mit Schnellkupplungen.
- Handbrauseschlauch aus Edelstahl AISI 304

FRANÇAIS

La douche extérieure en acier inoxydable noir de haute qualité. Avec la douche à main pour l'extérieur modèle BUDONI est une douche en acier inoxydable satiné Aisi Inox 316L avec entrée d'eau chaude et froide.

- Double mélangeur, il permet d'avoir de l'eau chaude de la tête de douche et de la douchette à main.
- Douche à main
- Connexions d'eau dissimulées sur la base.
- Robinets en acier inoxydable Aisi 316L.
- Connexion d'eau par le bas avec des raccords rapides.
- Flexible de douche à main en acier inoxydable AISI 304

ENGLISH

The black shower for outdoor stainless steel of high quality. With hand shower for outdoor model BUDONI is a shower in Satin Stainless Steel Aisi Inox 316L with hot and cold water inlet.

- Double mixer, it allows to have hot water from the shower head and from the hand shower.
- Hand shower
- Concealed water connections on the base.
- Taps in steel Aisi 316L.
- Water connection from the bottom with rapid connections.
- AISI 304 stainless steel hand shower hose

ESPAÑOL

Ducha de exterior de acero inoxidable de alta calidad. Con ducha de mano para exteriores el modelo BUDONI es una ducha en acero inoxidable satinado Aisi Inox 316L con entrada de agua caliente y fría.

- Mezclador doble, permite tener agua caliente desde el cabezal de la ducha y desde la teleducha.
- Ducha de mano
- Conexiones de agua ocultas en la base.
- Grifos de acero inoxidable Aisi 316L.
- Conexión de agua desde la parte inferior con acoples rápidos.
- Manguera de ducha manual de acero inoxidable AISI 304

DOCCIA-BUDONI-NERA

8025431016798

ACCIAIO
INOX 316L
NAUTICO NAUTICAL



VERTICAL
RAIN JET



ACQUA CALDA E
FREDDA
HOT AND COLD WATER



INCLUDE UNA SACCA
DI PROTEZIONE
INCLUDES PROTECTIVE
BAG



PUÒ ESSERE
FACILMENTE
SMONTATA PER
L'INVERNO
CAN EASILY BE STORED
AT HOME IN THE WINTER



PRODOTTO IN DUE PARTI.
SCATOLA FACILE DA
MANEGGIARE (-120CM)
PRODUCT IN TWO PARTS.
EASY TO HANDLE BOX
(-120CM)



UGELLI ANTICALCARE
ANTI-SCALE NOZZLES



SISTEMA
INSTALLAZIONE C-BOX
INCLUSO INCLUDED

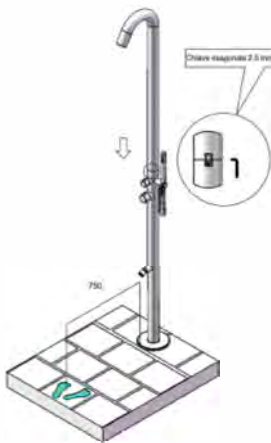
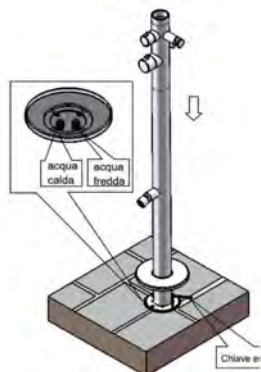
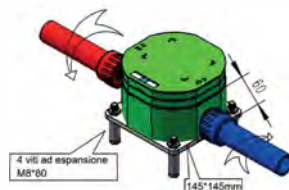

COLLEGAMENTO ACQUA NELLA
PARTE INFERIORE.
ACQUA CALDA E FREDDA.
WATER CONNECTION AT THE
BOTTOM.
HOT AND COLD WATER.

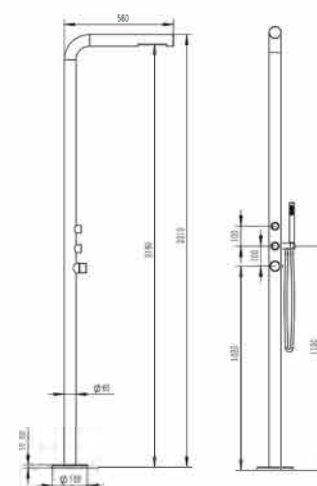

PESO
10,3 Kg

COLORE
Nero satinato Matt Black

COLLEGAMENTO
acqua calda - acqua fredda



CHIA INOX

Doccia inox da giardino di alta qualità. La doccia con doccino per esterno modello CHIA è una doccia in Acciaio Satinato Aisi Inox 316L con ingresso acqua calda e fredda. La doccia per esterno con acqua calda e fredda, è ottima per uso commerciale, privato, per piscina esterna-interna, giardino, per il bagno di casa, stazioni termali o SPA.

- Doppio miscelatore, permette di avere acqua calda dal soffione e dalla doccetta a mano.
- Doccetta a mano
- Attacchi acqua a scomparsa sulla base.
- Rubinetteria in Acciaio Aisi 316L.
- Collegamento acqua dal basso con attacchi rapidi.
- Flessibile del doccino in acciaio inox AISI 304

DEUTSCH

Hochwertige Gartendusche aus Edelstahl. Die Außendusche mit Handbrause Modell CHIA ist eine Dusche aus 316L Aisi Inox Satin-Edelstahl mit Warm- und Kaltwasseranschluss.

- Doppelmischer, ermöglicht heißes Wasser von der Kopfbrause und von der Handbrause zu haben.
- Handbrause
- Verdeckte Wasseranschlüsse auf der Basis
- Aisi 316L Stahl Armaturen
- Wasseranschluss von unten mit Schnellkupplungen
- Handbrauseschlauch aus Edelstahl AISI 304

FRANÇAIS

Douche de jardin en acier inoxydable de haute qualité. La douche extérieure avec douchette modèle CHIA est une douche en acier inoxydable 316L Aisi Inox Satin avec arrivée d'eau chaude et froide.

- Double mélangeur, permet d'avoir de l'eau chaude de la tête de douche et de la douchette à main.
- Douche à main
- Connexions d'eau dissimulées sur la base.
- Raccords en acier Aisi 316L.
- Connexion d'eau par le bas avec des raccords rapides.
- Flexible de douche à main en acier inoxydable AISI 304

ENGLISH

High-quality stainless steel garden shower. The outdoor shower with hand shower model CHIA is a 316L Aisi Inox Satin Stainless Steel shower with hot and cold water inlet.

- Double mixer, allows you to have hot water from the shower head and hand shower.
- Hand shower
- Concealed water connections on the base.
- Aisi 316L steel faucets.
- Water connection from the bottom with quick couplings.
- AISI 304 stainless steel hand shower hose

ESPAÑOL

Ducha de jardín de acero inoxidable de alta calidad. La ducha de exterior con ducha de mano modelo CHIA es una ducha de acero inoxidable 316L Aisi Inox Satinado con entrada de agua caliente y fría.

- Mezclador doble, permite tener agua caliente del cabezal de la ducha y de la ducha de mano.
- Ducha de mano.
- Conexiones de agua ocultas en la base.
- Herrajes de acero Aisi 316L.
- Conexión de agua por la parte inferior con acoples rápidos.
- Manguera de ducha manual de acero inoxidable AISI 304

DOCCIA-CHIA-INOX

8025431016712

ACCIAIO
INOX 316L
NAUTICO NAUTICAL



VERTICAL
RAIN JET



ACQUA CALDA E
FREDDA
HOT AND COLD WATER



INCLUDE UNA SACCA
DI PROTEZIONE
INCLUDES PROTECTIVE
BAG



PUÒ ESSERE
FACILMENTE
SMONTATA PER
L'INVERNO
CAN EASILY BE STORED
AT HOME IN THE WINTER



PRODOTTO IN DUE PARTI.
SCATOLA FACILE DA
MANEGGIARE (-120CM)
PRODUCT IN TWO PARTS.
EASY TO HANDLE BOX
(-120CM)



UGELLI ANTICALCARE
ANTI-SCALE NOZZLES



SISTEMA
INSTALLAZIONE C-BOX
INCLUSO INCLUDED

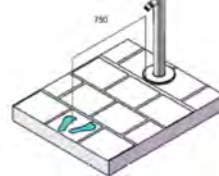
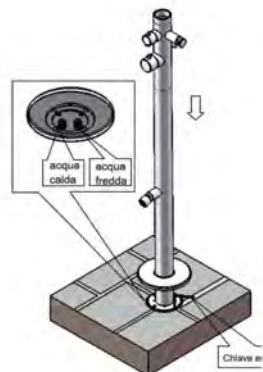
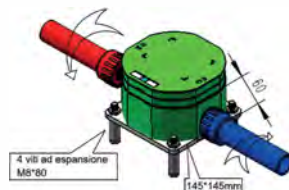

COLLEGAMENTO ACQUA NELLA
PARTE INFERIORE.
ACQUA CALDA E FREDDA.
WATER CONNECTION AT THE
BOTTOM.
HOT AND COLD WATER.

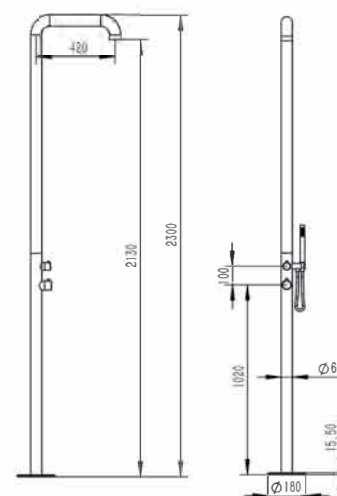
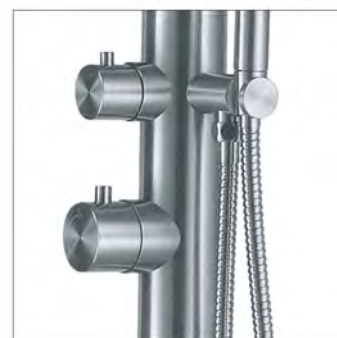

PESO
9,5 Kg

COLORE
Inox satinato

COLLEGAMENTO
acqua calda - acqua fredda



CHIA NERA

Doccia inox di colore nero per esterno di alta qualità. La doccia con doccino modello CHIA è una doccia in Acciaio Satinato Aisi Inox 316L con ingresso acqua calda e fredda. La doccia per esterno con acqua calda e fredda, è ottima per uso commerciale, privato, per piscina esterna-interna, giardino, per il bagno di casa, SPA o stazione termale.

- Doppio miscelatore, permette di avere acqua calda dal soffione e dalla doccetta a mano.
- Doccetta a mano
- Attacchi acqua a scomparsa sulla base.
- Rubinetteria in Acciaio Aisi 316L.
- Collegamento acqua dal basso con attacchi rapidi.
- Flessibile del doccino in acciaio inox AISI 304

DEUTSCH

Hochwertige schwarze Edelstahldusche für den Außenbereich. Die Dusche mit Handbrause Modell CHIA ist eine Dusche aus satiniertem Edelstahl Aisi Inox 316L mit Warm- und Kaltwasseranschluss.

- Doppelmischer, ermöglicht es, heißes Wasser von der Kopfbrause und von der Handbrause zu haben.
- Handbrause
- Verdeckte Wasseranschlüsse an der Basis.
- Armaturen aus rostfreiem Stahl Aisi 316L.
- Wasseranschluss von unten mit Schnellkupplungen.
- Handbrauseschlauch aus Edelstahl AISI 304

FRANÇAIS

Douche en acier inoxydable noir de haute qualité pour usage extérieur. La douche avec douchette modèle CHIA est une douche en acier inoxydable satiné Aisi Inox 316L avec arrivée d'eau chaude et froide.

- Double mélangeur, permet d'avoir de l'eau chaude de la tête de douche et de la douchette à main.
- Douchette à main
- Raccordements d'eau dissimulés sur la base.
- Robinets en acier inoxydable Aisi 316L.
- Raccordement d'eau par le bas avec des raccords rapides.
- Flexible de douche à main en acier inoxydable AISI 304

ENGLISH

High quality black stainless steel shower for outdoor use. The shower with hand shower model CHIA is a Satin Stainless Steel Aisi Inox 316L shower with hot and cold water inlet. The outdoor shower with hot

- Double mixer, allows to have hot water from the shower head and from the hand shower.
- Hand shower
- Concealed water connections on the base.
- Aisi 316L stainless steel taps.
- Water connection from the bottom with quick couplings.
- AISI 304 stainless steel hand shower hose

ESPAÑOL

Ducha de acero inoxidable negro de alta calidad para exteriores. La ducha con ducha de mano modelo CHIA es una ducha de acero inoxidable satinado Aisi Inox 316L con entrada de agua caliente y fría.

- Mezclador doble, permite tener agua caliente desde el cabezal de la ducha y desde la ducha de mano.
- Ducha de mano
- Conexiones de agua ocultas en la base.
- Grifos de acero inoxidable Aisi 316L.
- Conexión de agua desde la parte inferior con acoples rápidos.
- Manguera de ducha manual de acero inoxidable AISI 304

DOCCIA-CHIA-NERA

8025431016729



VERTICAL
RAIN JET



ACQUA CALDA E
FREDDA
HOT AND COLD WATER



INCLUDE UNA SACCA
DI PROTEZIONE
INCLUDES PROTECTIVE
BAG



PUÒ ESSERE
FACILMENTE
SMONTATA PER
L'INVERNO
CAN EASILY BE STORED
AT HOME IN THE WINTER



PRODOTTO IN DUE PARTI.
SCATOLA FACILE DA
MANEGGIARE (-120CM)
PRODUCT IN TWO PARTS.
EASY TO HANDLE BOX
(-120CM)



UGELLI ANTICALCARE
ANTI-SCALE NOZZLES



SISTEMA
INSTALLAZIONE C-BOX
INCLUSO INCLUDED

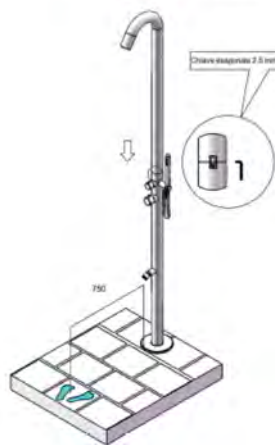
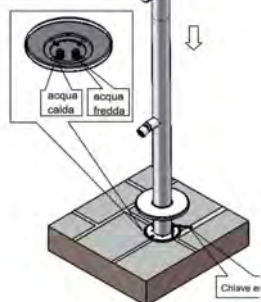
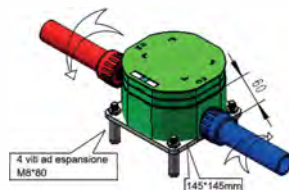

COLLEGAMENTO ACQUA NELLA
PARTE INFERIORE.
ACQUA CALDA E FREDDA.
WATER CONNECTION AT THE
BOTTOM.
HOT AND COLD WATER.

PESO
9,5 Kg

COLORE
Nero satinato Matt Black

COLLEGAMENTO
acqua calda - acqua fredda

ACCIAIO
INOX 316L
NAUTICO NAUTICAL

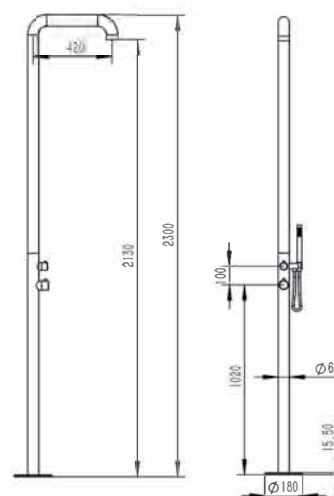
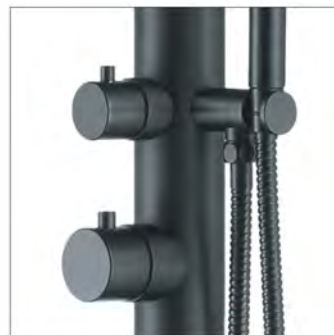



PALAU INOX

Doccia di alta qualità per piscina è stata pensata e realizzata per qualsiasi installazione all'aperto. La doccia con lavapiedi modello PALAU è una doccia in Acciaio Satinato Aisi Inox 316L con ingresso acqua calda e fredda. La doccia per esterno è ottima per uso commerciale, privato, per piscina esterna-interna, giardino o per il bagno di casa. Altezza 2439 mm. diametro 60 mm.

- Doppio miscelatore, permette di avere acqua calda dal soffione e dal lavapiedi.
- Attacchi acqua a scomparsa sulla base.
- Rubinetteria in Acciaio Aisi 316L.
- Collegamento acqua dal basso con attacchi rapido

DEUTSCH

Diese hochwertige Pool-Dusche wurde für jede Außeninstallation entworfen und hergestellt. Die Dusche mit Fußwaschhahn Modell PALAU ist eine Dusche aus satiniertem Edelstahl Aisi Inox 316L mit Warm- und Kaltwasseranschluss.

- Doppelmischer, liefert Warmwasser aus der Kopfbrause und aus der Fußbrause.
- Verdeckte Wasseranschlüsse auf der Basis.
- Wasserhähne aus Stahl Aisi 316L.
- Wasseranschluss von unten mit Schnellkupplungen.

FRANÇAIS

Douche de haute qualité pour piscine a été conçue et fabriquée pour toute installation extérieure. La douche avec lave-pieds modèle PALAU est une douche en acier inoxydable satiné Aisi Inox 316L avec entrée d'eau chaude et froide.

- Double mélangeur, permet d'avoir de l'eau chaude de la douchette et du lave-pieds.
- Raccordements d'eau encastrés sur la base.
- Robinets en acier Aisi 316L.
- Raccordement d'eau par le bas avec raccords rapides.

ENGLISH

High quality shower for swimming pool has been designed and built for any outdoor installation. The shower with foot wash model PALAU is a shower in Satin Stainless Steel Aisi Inox 316L with hot and cold water inlet.

- Double mixer, it allows to have hot water from the shower head and from the footwash.
- Concealed water connections on the base.
- Taps in Aisi 316L Steel.
- Water connection from the bottom with quick couplings.

ESPAÑOL

Esta ducha de piscina de alta calidad ha sido diseñada y fabricada para cualquier instalación exterior. La ducha con lavapiés modelo PALAU es una ducha de acero inoxidable satinado Aisi Inox 316L con entrada de agua caliente y fría.

- Mezclador doble, permite tener agua caliente del cabezal de la ducha y del lavapiés.
- Conexiones de agua ocultas en la base.
- Grifos en acero Aisi 316L.
- Conexión de agua por la parte inferior con acoples rápidos.

DOCCIA-PALAU-INOX

8025431016736



VERTICAL
RAIN JET



ACQUA CALDA E
FREDDA
HOT AND COLD WATER



INCLUDE UNA SACCA
DI PROTEZIONE
INCLUDES PROTECTIVE
BAG



PUÒ ESSERE
FACILMENTE
SMONTATA PER
L'INVERNO
CAN EASILY BE STORED
AT HOME IN THE WINTER



PRODOTTO IN DUE PARTI.
SCATOLA FACILE DA
MANEGGIARE (-120CM)
PRODUCT IN TWO PARTS.
EASY TO HANDLE BOX
(-120CM)



UGELLI ANTICALCARE
ANTI-SCALE NOZZLES



SISTEMA
INSTALLAZIONE C-BOX
INCLUSO INCLUDED

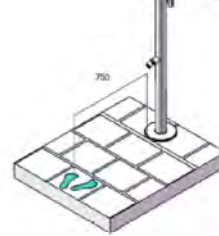
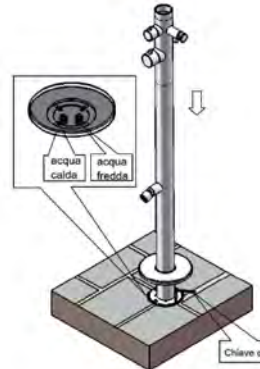
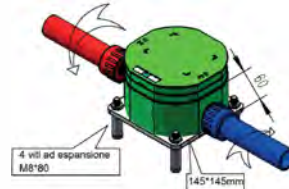

COLLEGAMENTO ACQUA NELLA
PARTE INFERIORE.
ACQUA CALDA E FREDDA.
WATER CONNECTION AT THE
BOTTOM.
HOT AND COLD WATER.

ACCIAIO
INOX 316L
NAUTICO NAUTICAL

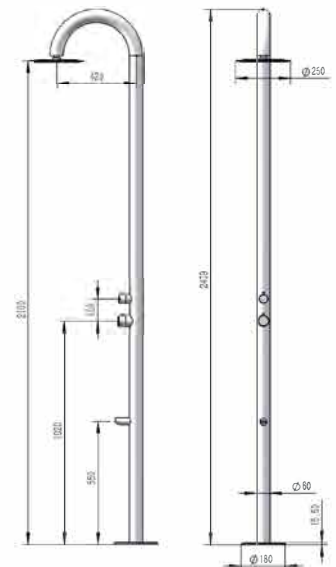

PESO
16 Kg

COLORE
Inox satinato

COLLEGAMENTO
acqua calda - acqua fredda

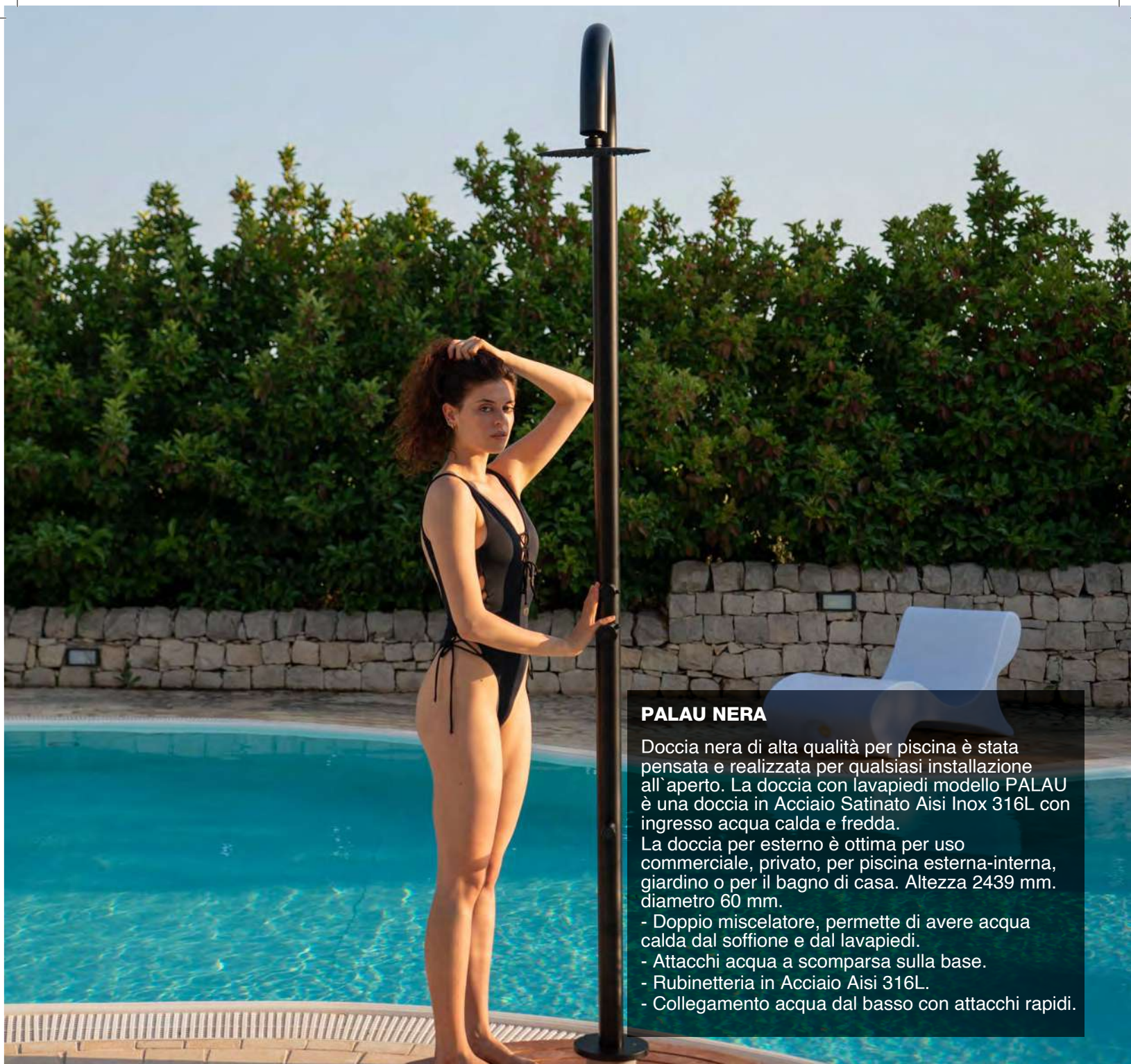

PALAU NERA

Doccia nera di alta qualità per piscina è stata pensata e realizzata per qualsiasi installazione all'aperto. La doccia con lavapiedi modello PALAU è una doccia in Acciaio Satinato Aisi Inox 316L con ingresso acqua calda e fredda.

La doccia per esterno è ottima per uso commerciale, privato, per piscina esterna-interna, giardino o per il bagno di casa. Altezza 2439 mm. diametro 60 mm.

- Doppio miscelatore, permette di avere acqua calda dal soffione e dal lavapiedi.
- Attacchi acqua a scomparsa sulla base.
- Rubinetteria in Acciaio Aisi 316L.
- Collegamento acqua dal basso con attacchi rapidi.

DEUTSCH

Hochwertige schwarze Dusche für Schwimmbad wurde für jede Außeninstallation entworfen und hergestellt. Die Dusche mit Fußwaschhahn Modell PALAU ist eine Dusche aus satiniertem Edelstahl Aisi Inox 316L mit Warm- und Kaltwasseranschluss.

- Doppelmischer, liefert Warmwasser aus der Kopfbrause und aus der Fußbrause.
- Verdeckte Wasseranschlüsse am Sockel.
- Armaturen aus Stahl Aisi 316L.
- Wasseranschluss von unten mit Schnellkupplungen.

FRANÇAIS

Douche noire pour piscine de haute qualité a été conçue et fabriquée pour toute installation extérieure. La douche avec lave-pieds modèle PALAU est une douche en acier inoxydable satiné Aisi Inox 316 avec entrée d'eau chaude et froide.

- Double mélangeur, permet d'avoir de l'eau chaude de la douchette et du lave-pieds.
- Raccordements d'eau encastrés sur la base.
- Robinets en acier Aisi 316L.
- Raccordement d'eau par le bas avec raccords rapides.

ENGLISH

High quality black shower for swimming pool has been thought and realized for any outdoor installation. The shower with foot wash model PALAU is a shower in Satin Stainless Steel Aisi Inox 316L with hot and cold water inlet.

- Double mixer, it allows to have hot water from the shower head and from the footwash.
- Concealed water connections on the base.
- Taps in Aisi 316L Steel.
- Water connection from the bottom with quick couplings.

ESPAÑOL

La ducha negra de alta calidad para piscina ha sido diseñada y fabricada para cualquier instalación exterior. La ducha con lavado de pies modelo PALAU es una ducha de acero inoxidable satinado Aisi Inox 316L con entrada de agua caliente y fría.

- Mezclador doble, permite tener agua caliente del cabezal de la ducha y del lavapiés.
- Conexiones de agua ocultas en la base.
- Grifos en acero Aisi 316L.
- Conexión de agua por la parte inferior con acoples rápidos.

DOCCIA-PALAU-NERA

8025431016804



VERTICAL
RAIN JET



ACQUA CALDA E
FREDDA
HOT AND COLD WATER



INCLUDE UNA SACCA
DI PROTEZIONE
INCLUDES PROTECTIVE
BAG



PUÒ ESSERE
FACILMENTE
SMONTATA PER
L'INVERNO
CAN EASILY BE STORED
AT HOME IN THE WINTER



PRODOTTO IN DUE PARTI.
SCATOLA FACILE DA
MANEGGIARE (-120CM)
PRODUCT IN TWO PARTS.
EASY TO HANDLE BOX
(-120CM)



UGELLI ANTICALCARE
ANTI-SCALE NOZZLES

SISTEMA
INSTALLAZIONE C-BOX
INCLUSO INCLUDED

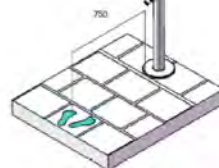
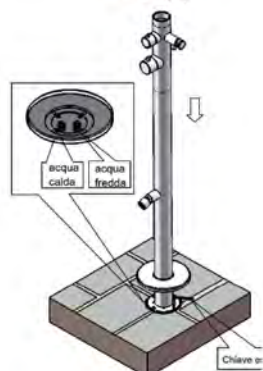
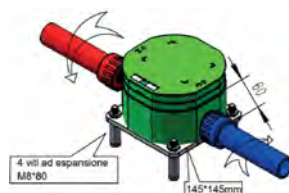

COLLEGAMENTO ACQUA NELLA
PARTE INFERIORE.
ACQUA CALDA E FREDDA.
WATER CONNECTION AT THE
BOTTOM.
HOT AND COLD WATER.

PESO
16 Kg

COLORE
Nero satinato Matt Black

COLLEGAMENTO
acqua calda - acqua fredda

ACCIAIO
INOX 316L
NAUTICO NAUTICAL

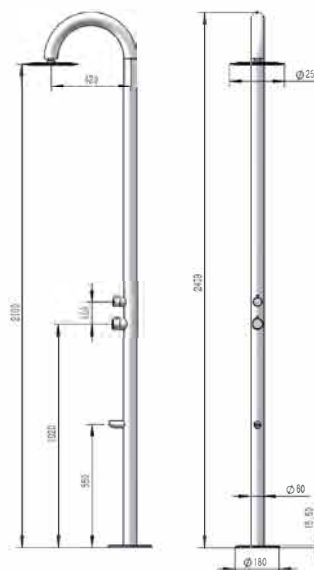

PALAU FREDDA

Doccia di alta qualità per piscina è stata pensata e realizzata per qualsiasi installazione all'aperto. La doccia con lavapiedi modello PALAU è una doccia in Acciaio Satinato Aisi Inox 316L con ingresso solo acqua fredda. La doccia per esterno è ottima per uso commerciale, privato, per piscina esterna-interna, giardino, Terme o per il bagno di casa. Altezza 2439 mm. diametro 60 mm.

ESPAÑOL

Esta ducha de piscina de alta calidad ha sido diseñada y fabricada para cualquier instalación exterior. La ducha con lavapies modelo PALAU es una ducha de acero inoxidable satinado Aisi Inox 316L con entrada de agua caliente y fría. La ducha de exterior es excelente tanto para uso comercial como privado, piscina exterior-interior, jardín o baño de casa. Altura 2439 mm. diámetro 60 mm.

ENGLISH

High quality shower for swimming pool has been designed and built for any outdoor installation. The shower with foot wash model PALAU is a shower in Satin Stainless Steel Aisi Inox 316L with hot and cold water inlet. The outdoor shower is excellent for commercial, private use, for outdoor-interior swimming pool, garden or for the bathroom at home. Height 2439 mm. diameter 60 mm.

FRANÇAIS

Douche de haute qualité pour piscine a été conçue et fabriquée pour toute installation extérieure. La douche avec lave-pieds modèle PALAU est une douche en acier inoxydable satiné Aisi Inox 316L avec entrée d'eau chaude et froide. La douche extérieure est excellente pour un usage commercial, un usage privé, une piscine extérieure-intérieure, un jardin ou une salle de bain domestique. Hauteur 2439 mm. diamètre 60 mm.

DEUTSCH

Diese hochwertige Pool-Dusche wurde für jede Außeninstallation entworfen und hergestellt. Die Dusche mit Fußwaschhahn Modell PALAU ist eine Dusche aus satiniertem Edelstahl Aisi Inox 316L mit Warm- und Kaltwasseranschluss. Die Außendusche eignet sich hervorragend für die gewerbliche Nutzung, den privaten Gebrauch, das Schwimmbad im Freien, den Garten oder das heimische Badezimmer. Höhe 2439 mm. Durchmesser 60 mm.

DOCCIA-PALAU-FREDDA

8025431150959



VERTICAL
RAIN JET



SOLO ACQUA FREDDA
COLD WATER ONLY



INCLUDE UNA SACCA
DI PROTEZIONE
INCLUDES PROTECTIVE
BAG



PUÒ ESSERE
FACILMENTE
SMONTATA PER
L'INVERNO
CAN EASILY BE STORED
AT HOME IN THE WINTER



PRODOTTO IN DUE PARTI.
SCATOLA FACILE DA
MANEGGIARE (-120CM)
PRODUCT IN TWO PARTS.
EASY TO HANDLE BOX
(-120CM)



UGELLI ANTICALCARE
ANTI-SCALE NOZZLES



sistema installazione

C-BOX (Solo Fredda)



COLLEGAMENTO ACQUA NELLA
PARTE INFERIORE.
C-BOX ACQUA SOLO FREDDA
WATER CONNECTION AT THE
BOTTOM. ONLY COLD WATER

ACCIAIO
INOX 316L
NAUTICO NAUTICAL

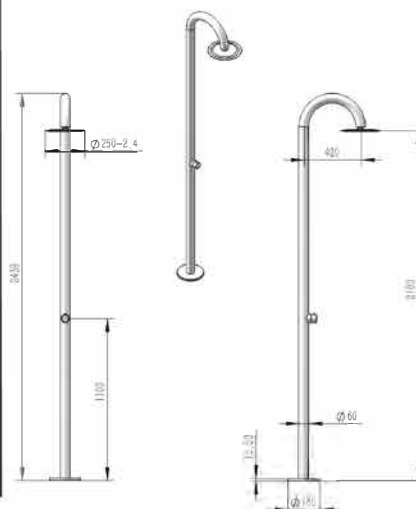

PESO
16 KG

COLORE
Inox satinato

COLLEGAMENTO
acqua fredda



PULA INOX

Doccia per giardino alta qualità è stata pensata e realizzata per qualsiasi installazione all'aperto. La doccia con doccino modello PULA è una doccia in Acciaio Satinato Aisi Inox 316L con ingresso acqua calda e fredda. La doccia per esterno è ottima per uso commerciale, privato, per piscina esterna-interna, giardino, per il bagno di casa, SPA o stabilimento balneare. Altezza 230 cm. diametro 60 mm.

- Doppio miscelatore, permette di avere acqua calda dal soffione e dal doccino mobile.
- Attacchi acqua a scomparsa sulla base.
- Rubinetteria in Acciaio Aisi 316L.
- Collegamento acqua dal basso con attacchi rapidi.
- Flessibile del doccino in acciaio inox AISI 304

DEUTSCH

Die hochwertige Gartendusche wurde für jede Außeninstallation entworfen und hergestellt. Die Dusche mit Handbrause Modell PULA ist eine Dusche aus satiniertem Edelstahl Aisi Inox 316L mit Warm- und Kaltwasseranschluss.

- Doppelmischer, liefert Warmwasser aus der Kopfbrause und aus der Handbrause.
- Verdeckte Wasseranschlüsse an der Basis.
- Armaturen aus Aisi 316L Stahl.
- Wasseranschluss von unten mit Schnellkupplungen.
- Handbrauseschlauch aus Edelstahl AISI 304

FRANÇAIS

La douche de jardin de haute qualité est conçue et fabriquée pour toute installation extérieure. La douche avec douchette modèle PULA est une douche en acier inoxydable satiné Aisi Inox 316L avec arrivée d'eau chaude et froide.

- Double mélangeur, permet d'avoir de l'eau chaude à partir de la tête de douche et de la douchette mobile.
- Raccordements d'eau dissimulés sur la base.
- Robinets en acier Aisi 316L.
- Raccordement d'eau par le bas avec des raccords rapides.
- Flexible de douche à main en acier inoxydable AISI 304

ENGLISH

High quality garden shower is designed and manufactured for any outdoor installation. The shower with hand shower model PULA is a shower in Satin Stainless Steel Aisi Inox 316L with hot and cold water inlet.

- Double mixer, it allows to have hot water from the shower head and from the mobile shower.
- Concealed water connections on the base.
- Aisi 316L stainless steel taps.
- Water connection from the bottom with quick couplings.
- AISI 304 stainless steel hand shower hose

ESPAÑOL

La ducha de jardín de alta calidad está diseñada y fabricada para cualquier instalación exterior. La ducha con teleducha modelo PULA es una ducha de acero inoxidable satinado Aisi Inox 316L con entrada de agua fría y caliente.

- Mezclador doble, permite disponer de agua caliente del cabezal de la ducha y de la teleducha móvil.
- Conexiones de agua ocultas en la base.
- Grifos en acero Aisi 316L.
- Conexión de agua por la parte inferior con acoples rápidos.
- Manguera de ducha manual de acero inoxidable AISI 304

DOCCIA-PULA-INOX

8025431016781



VERTICAL
RAIN JET



ACQUA CALDA E
FREDDA
HOT AND COLD WATER



INCLUDE UNA SACCA
DI PROTEZIONE
INCLUDES PROTECTIVE
BAG



PUÒ ESSERE
FACILMENTE
SMONTATA PER
L'INVERNO
CAN EASILY BE STORED
AT HOME IN THE WINTER



PRODOTTO IN DUE PARTI.
SCATOLA FACILE DA
MANEGGIARE (-120CM)
PRODUCT IN TWO PARTS.
EASY TO HANDLE BOX
(-120CM)



UGELLI ANTICALCARE
ANTI-SCALE NOZZLES



SISTEMA
INSTALLAZIONE C-BOX
INCLUSO INCLUDED

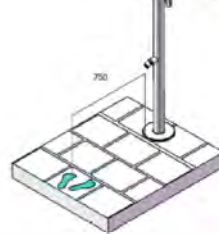
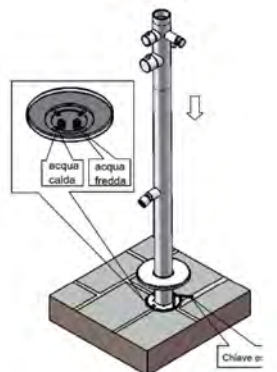
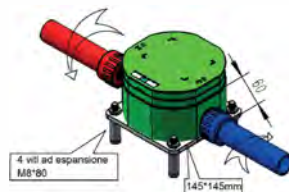

COLLEGAMENTO ACQUA NELLA
PARTE INFERIORE.
ACQUA CALDA E FREDDA.
WATER CONNECTION AT THE
BOTTOM.
HOT AND COLD WATER.

PESO
15,5 Kg

COLORE
Inox satinato

COLLEGAMENTO
acqua calda - acqua fredda

ACCIAIO
INOX 316L
NAUTICO NAUTICAL

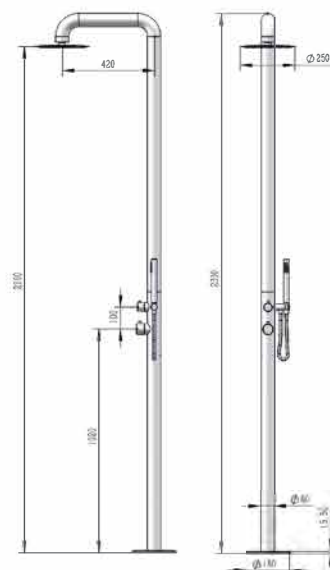

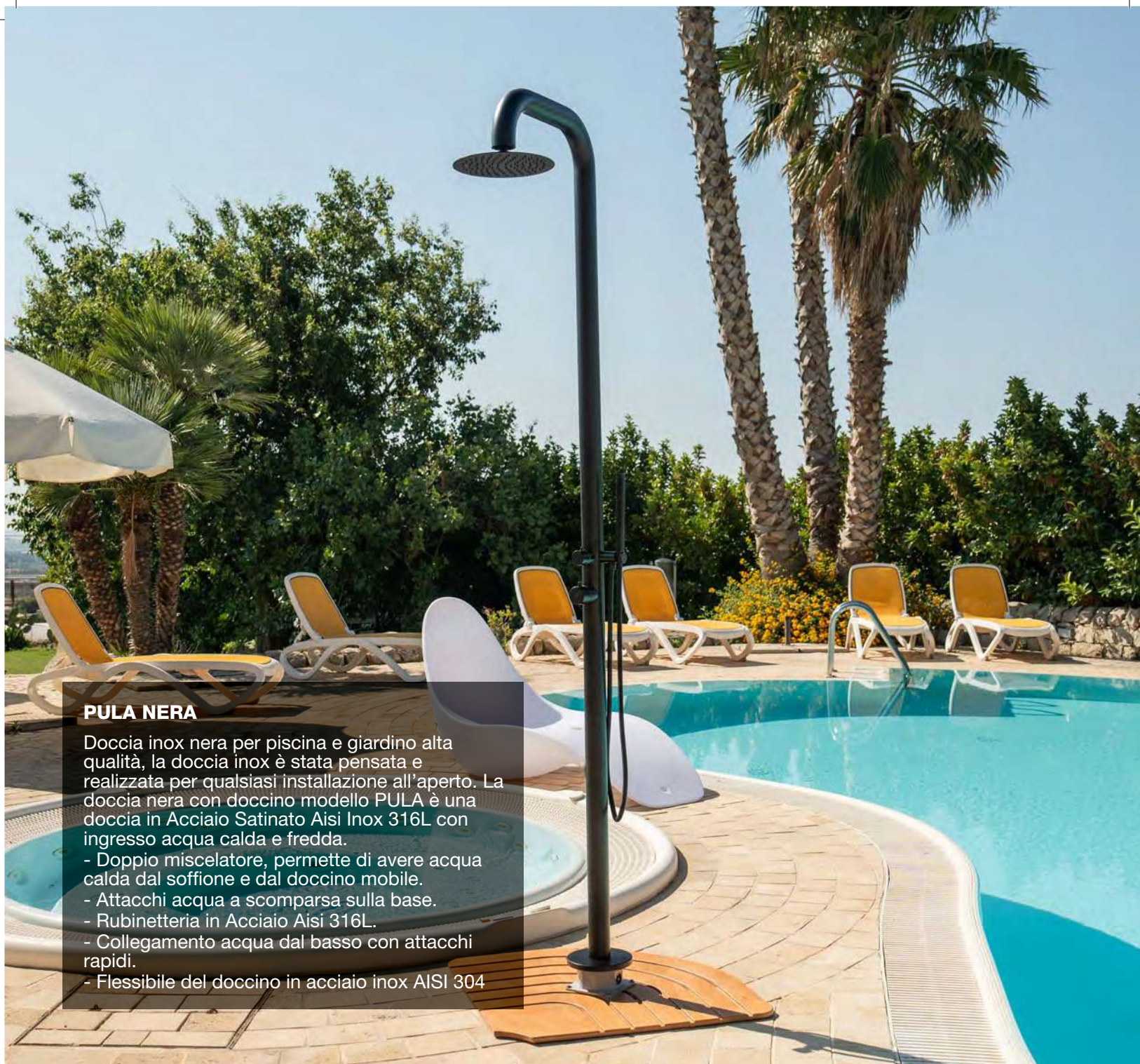

PULA NERA

Doccia inox nera per piscina e giardino alta qualità, la doccia inox è stata pensata e realizzata per qualsiasi installazione all'aperto. La doccia nera con doccino modello PULA è una doccia in Acciaio Satinato Aisi Inox 316L con ingresso acqua calda e fredda.

- Doppio miscelatore, permette di avere acqua calda dal soffione e dal doccino mobile.
- Attacchi acqua a scomparsa sulla base.
- Rubinetteria in Acciaio Aisi 316L.
- Collegamento acqua dal basso con attacchi rapidi.
- Flessibile del doccino in acciaio inox AISI 304

DEUTSCH

AHochwertige schwarze Edelstahldusche für Pool und Garten, die Edelstahldusche ist für jede Außeninstallation konzipiert und hergestellt. Die schwarze Dusche mit Handbrause Modell PULA ist eine Dusche aus satiniertem Edelstahl Aisi Inox 316L mit Warm- und Kaltwasseranschluss.

Doppelmischer, liefert Warmwasser aus der Kopfbrause und aus der mobilen Handbrause.

Verdeckte Wasseranschlüsse an der Basis.

Armaturen aus Aisi 316L Stahl.

Wasseranschluss von unten mit Schnellkupplungen.

Handbrauseschlauch aus Edelstahl AISI 304I

FRANÇAIS

Douche noire en acier inoxydable de haute qualité pour piscine et jardin, la douche en acier inoxydable est conçue et fabriquée pour toute installation extérieure. La douche noire avec douchette modèle PULA est une douche en acier inoxydable satiné Aisi Inox 316L avec arrivée d'eau chaude et froide.

- Double mélangeur, permet d'avoir de l'eau chaude à partir de la tête de douche et de la douchette mobile.

- Raccordements d'eau dissimulés sur la base.

- Robinets en acier Aisi 316L.

- Raccordement d'eau par le bas avec des raccords rapides.

- Flexible de douche à main en acier inoxydable AISI 304

ENGLISH

High quality black stainless steel shower for pool and garden, the stainless steel shower is designed and manufactured for any outdoor installation. The black shower with hand shower model PULA is a shower in Satin Stainless Steel Aisi Inox 316L with hot and cold water inlet.

- Double mixer, it allows to have hot water from the shower head and from the mobile shower.

- Concealed water connections on the base.

- Aisi 316L stainless steel taps.

- Water connection from the bottom with quick couplings.

- AISI 304 stainless steel hand shower hose

ESPAÑOL

Ducha de acero inoxidable negra de alta calidad para piscina y jardín, la ducha de acero inoxidable está diseñada y fabricada para cualquier instalación exterior. La ducha negra con ducha de mano modelo PULA es una ducha de acero inoxidable satinado Aisi Inox 316L con entrada de agua caliente y fría.

- Mezclador doble, permite disponer de agua caliente del cabezal de la ducha y de la teleducha móvil.

- Conexiones de agua ocultas en la base.

- Grifos en acero Aisi 316L.

- Conexión de agua por la parte inferior con acoples rápidos.

- Manguera de ducha manual de acero inoxidable AISI 304

DOCCIA-PULA-NERA

8025431016828



VERTICAL
RAIN JET



ACQUA CALDA E
FREDDA
HOT AND COLD WATER



INCLUDE UNA SACCA
DI PROTEZIONE
INCLUDES PROTECTIVE
BAG



PUÒ ESSERE
FACILMENTE
SMONTATA PER
L'INVERNO
CAN EASILY BE STORED
AT HOME IN THE WINTER



PRODOTTO IN DUE PARTI.
SCATOLA FACILE DA
MANEGGIARE (-120CM)
PRODUCT IN TWO PARTS.
EASY TO HANDLE BOX
(-120CM)



UGELLI ANTICALCARE
ANTI-SCALE NOZZLES



SISTEMA
INSTALLAZIONE C-BOX
INCLUSO INCLUDED

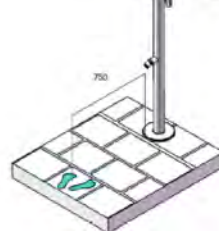
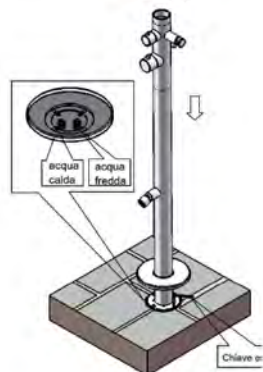
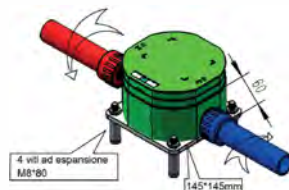

COLLEGAMENTO ACQUA NELLA
PARTE INFERIORE.
ACQUA CALDA E FREDDA.
WATER CONNECTION AT THE
BOTTOM.
HOT AND COLD WATER.

PESO
15,5 Kg

COLORE
Nero satinato Matt Black

COLLEGAMENTO
acqua calda - acqua fredda

ACCIAIO
INOX 316L
NAUTICO NAUTICAL

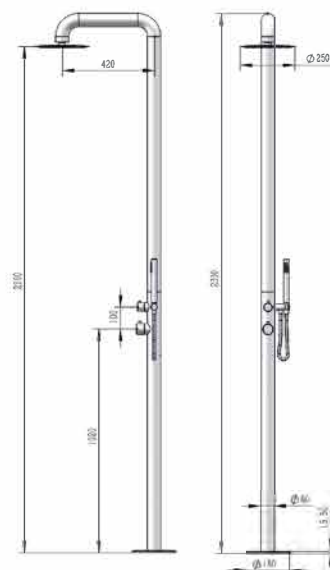



QUARTU INOX

Doccia inox esterna per giardino alta qualità, la doccia inox è stata pensata e realizzata per qualsiasi installazione all'aperto. La doccia con lavapiedi modello QUARTU è una doccia in Acciaio Satinato Aisi Inox 316L con ingresso acqua calda e fredda. La doccia per esterno è ottima per uso commerciale, privato, per piscina esterna-interna, giardino o per il bagno di casa. Altezza 2289 mm. diametro 60 mm.

- Doppio miscelatore, permette di avere acqua calda dal soffione e dal lavapiedi.
- Attacchi acqua a scomparsa sulla base.
- Rubinetteria in Acciaio Aisi 316L.
- Collegamento acqua dal basso con attacchi rapidi.

DEUTSCH

Die Edelstahl-Außendusche für den Garten ist von hoher Qualität und wurde für jede Außeninstallation entworfen und hergestellt. Die Dusche mit Fußwaschung Modell QUARTU ist eine Dusche aus satiniertem Edelstahl Aisi Inox 316L mit Warm- und Kaltwasseranschluss.

- Doppelmischer, der es ermöglicht, warmes Wasser von der Kopfbrause und von der Fußbrause zu haben.
- Verdeckte Wasseranschlüsse an der Basis.
- Aisi 316L Stahlarmaturen.
- Wasseranschluss von unten mit Schnellkupplungen.

FRANÇAIS

Douche de jardin extérieure en acier inoxydable de haute qualité, la douche en acier inoxydable a été conçue et fabriquée pour toute installation extérieure. La douche avec lavage des pieds modèle QUARTU est une douche en acier inoxydable satiné Aisi Inox 316L avec entrée d'eau chaude et froide.

- Double mélangeur, il permet d'avoir de l'eau chaude de la douchette et du lave-pieds.
- Raccordements d'eau encastrés sur la base.
- Robinetterie en acier Aisi 316L.
- Raccordement d'eau par le bas avec raccords rapides.

ENGLISH

External stainless steel shower for garden high quality, the stainless steel shower has been designed and manufactured for any outdoor installation. The shower with foot wash model QUARTU is a shower in Satin Stainless Steel Aisi Inox 316L with hot and cold water inlet.

- Double mixer, it allows to have hot water from the shower head and from the footwash.
- Concealed water connections on the base.
- Taps in Aisi 316L Steel.
- Water connection from the bottom with quick couplings.

ESPAÑOL

Ducha exterior de acero inoxidable para jardín de alta calidad, la ducha de acero inoxidable está diseñada y fabricada para cualquier instalación exterior. La ducha con lavado de pies modelo QUARTU es una ducha de acero inoxidable satinado Aisi Inox 316L con entrada de agua caliente y fría.

- Mezclador doble, permite disponer de agua caliente del cabezal de la ducha y del lavapiés.
- Conexiones de agua ocultas en la base.
- Grifería de acero Aisi 316L.
- Conexión de agua por la parte inferior con acoples rápidos.

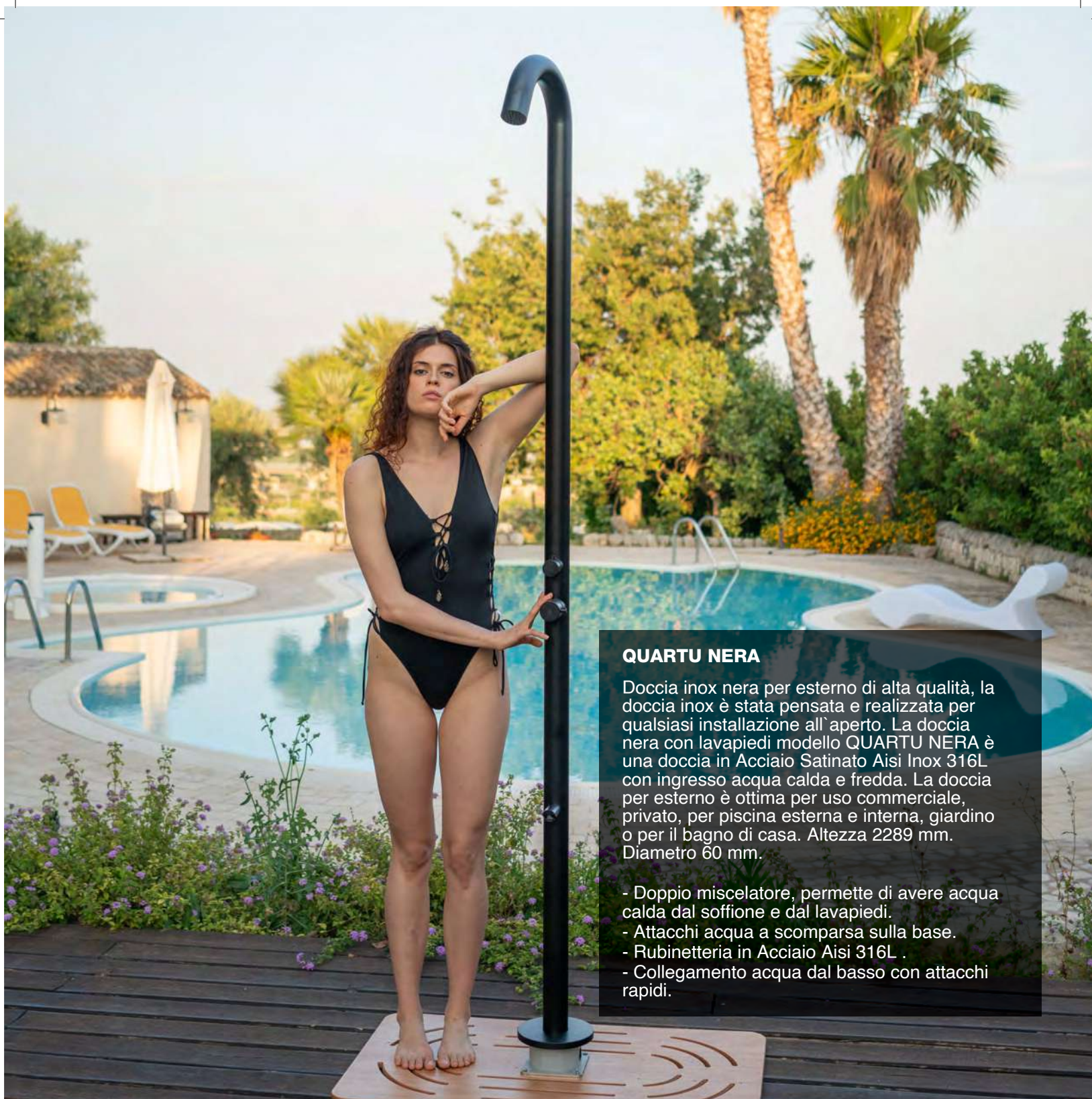

QUARTU NERA

Doccia inox nera per esterno di alta qualità, la doccia inox è stata pensata e realizzata per qualsiasi installazione all'aperto. La doccia nera con lavapiedi modello QUARTU NERA è una doccia in Acciaio Satinato Aisi Inox 316L con ingresso acqua calda e fredda. La doccia per esterno è ottima per uso commerciale, privato, per piscina esterna e interna, giardino o per il bagno di casa. Altezza 2289 mm. Diametro 60 mm.

- Doppio miscelatore, permette di avere acqua calda dal soffione e dal lavapiedi.
- Attacchi acqua a scomparsa sulla base.
- Rubinetteria in Acciaio Aisi 316L .
- Collegamento acqua dal basso con attacchi rapidi.

DEUTSCH

Hochwertige schwarze Edelstahldusche für den Außenbereich, die Edelstahldusche ist für jede Außeninstallation konzipiert und hergestellt. Die schwarze Dusche mit Fußwaschung Modell QUARTU NERA ist eine Dusche aus satiniertem Edelstahl Aisi Inox 316L mit Warm- und Kaltwasseranschluss.

- Doppelmischer, liefert heißes Wasser aus der Kopf- und Fußbrause.
- Verdeckte Wasseranschlüsse an der Basis.
- Armaturen aus Stahl Aisi 316L .
- Wasseranschluss von unten mit Schnellkupplungen.

FRANÇAIS

Douche noire en acier inoxydable de haute qualité pour l'extérieur, la douche en acier inoxydable est conçue et fabriquée pour toute installation extérieure. La douche noire avec lavage des pieds modèle QUARTU NERA est une douche en acier inoxydable Aisi Inox 316L satiné avec entrée d'eau chaude et froide.

- Double mélangeur, il permet d'avoir de l'eau chaude de la douchette et du lave-pieds.
- Raccordements d'eau encastrés sur la base.
- Robinetterie en acier Aisi 316L .
- Raccordement d'eau par le bas avec raccords rapides.

ENGLISH

High quality black stainless steel shower, the stainless steel shower is designed and manufactured for any outdoor installation. The black shower with foot wash model QUARTU NERA is a shower in SATIN Stainless Steel Aisi Inox 316L with hot and cold water inlet.

- Double mixer, it allows to have hot water from the shower head and from the foot-washing.
- Concealed water connections on the base.
- Taps in Aisi 316L Steel.
- Water connection from the bottom with quick couplings.

ESPAÑOL

Ducha de acero inoxidable negro de alta calidad para uso exterior, la ducha de acero inoxidable está diseñada y fabricada para cualquier instalación exterior. La ducha negra con lavado de pies modelo QUARTU NERA es una ducha de acero inoxidable satinado Aisi Inox 316L con entrada de agua caliente y fría.

- Mezclador doble, proporciona agua caliente del cabezal de la ducha y del lavapiés.
- Conexiones de agua ocultas en la base.
- Grifos en acero Aisi 316L .
- Conexión de agua por la parte inferior con acoples rápidos.

DOCCIA-QUARTU-NERA

8025431016743



DIAGONAL
RAIN JET



ACQUA CALDA E
FREDDA
HOT AND COLD WATER



INCLUDE UNA SACCA
DI PROTEZIONE
INCLUDES PROTECTIVE
BAG



PUÒ ESSERE
FACILMENTE
SMONTATA PER
L'INVERNO
CAN EASILY BE STORED
AT HOME IN THE WINTER



PRODOTTO IN DUE PARTI.
SCATOLA FACILE DA
MANEGGIARE (-120CM)
PRODUCT IN TWO PARTS.
EASY TO HANDLE BOX
(-120CM)



UGELLI ANTICALCARE
ANTI-SCALE NOZZLES



SISTEMA
INSTALLAZIONE C-BOX
INCLUSO INCLUDED

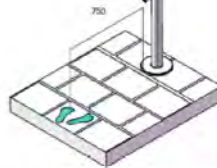
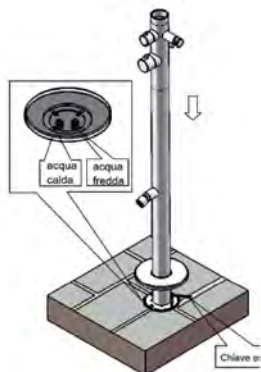
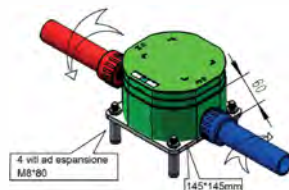

COLLEGAMENTO ACQUA NELLA
PARTE INFERIORE.
ACQUA CALDA E FREDDA.
WATER CONNECTION AT THE
BOTTOM.
HOT AND COLD WATER.

PESO
13,6 Kg

COLORE
Nero satinato Matt Black

COLLEGAMENTO
acqua calda - acqua fredda

ACCIAIO
INOX 316L
NAUTICO NAUTICAL

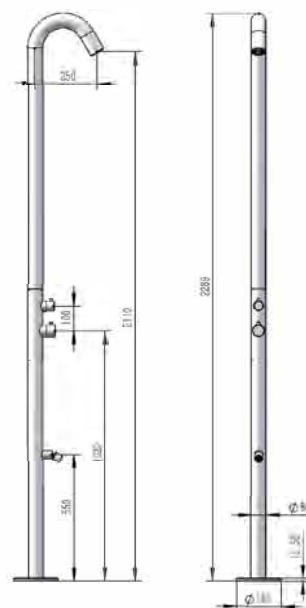



QUARTU CANNA DI FUCILE (GUN METAL)

Elegante doccia esterna per giardino di alta qualità colore canna di fucile, la doccia inox è stata pensata e realizzata per qualsiasi installazione all'aperto. La doccia con lavapiedi modello QUARTU è una doccia in Acciaio Aisi Inox 316L con ingresso acqua calda e fredda. La doccia per esterno è ottima per uso commerciale, privato, per piscina esterna-interna, giardino o per il bagno di casa. Altezza 2289 mm. Diametro 60 mm.

ESPAÑOL

Elegante ducha de jardín de alta calidad en color bronce de cañón, la ducha de acero inoxidable está diseñada y fabricada para cualquier instalación exterior. La ducha modelo QUARTU con lavapiés es una ducha de acero inoxidable 316L con entrada de agua caliente y fría. La ducha de exterior es excelente para el uso comercial, privado, en la piscina exterior, en el jardín o en el baño de casa. Altura 2289 mm. diámetro 60 mm.

ENGLISH

Elegant high quality gunmetal coloured outdoor garden shower, the stainless steel shower is designed and manufactured for any outdoor installation. The QUARTU model shower with footwash is a 316L Aisi Inox Steel shower with hot and cold water inlet. The outdoor shower is excellent for commercial, private, outdoor-interior pool, garden or home bathroom use. Height 2289 mm. diameter 60 mm.

FRANÇAIS

Élégante douche de jardin extérieure de haute qualité de couleur gunmetal, la douche en acier inoxydable est conçue et fabriquée pour toute installation extérieure. La douche modèle QUARTU avec lave-pieds est une douche en acier inoxydable Aisi 316L avec entrée d'eau chaude et froide. La douche extérieure est excellente pour une utilisation commerciale, privée, dans une piscine extérieure, un jardin ou une salle de bain domestique. Hauteur 2289 mm. Diamètre 60 mm.

DEUTSCH

Elegante, hochwertige Gartendusche in der Farbe Rotguss. Die Edelstahldusche ist für jede Außeninstallation konzipiert und hergestellt. Das Modell QUARTU mit Fußspülung ist eine Dusche aus 316L Aisi Inox Stahl mit Warm- und Kaltwasseranschluss. Die Außendusche eignet sich hervorragend für den gewerblichen, privaten Gebrauch, für den Außenpool, den Garten oder das heimische Badezimmer. Höhe 2289 mm. Durchmesser 60 mm.

DOCCIA-QUARTU-CANNA-FUCILE

8025431019676

SPECIALE TRATTAMENTO VERNICIATURA PVD
SPECIAL PVD VARNISHING TREATMENT



DIAGONAL RAIN JET



ACQUA CALDA E FREDDA
HOT AND COLD WATER



INCLUDE UNA SACCA DI PROTEZIONE
INCLUDES PROTECTIVE BAG



PUÒ ESSERE FACILMENTE SMONTATA PER L'INVERNO
CAN EASILY BE STORED AT HOME IN THE WINTER



PRODOTTO IN DUE PARTI.
SCATOLA FACILE DA MANEGGIARE (-120CM)
PRODUCT IN TWO PARTS.
EASY TO HANDLE BOX (-120CM)



UGELLI ANTICALCARE
ANTI-SCALE NOZZLES



SISTEMA INSTALLAZIONE C-BOX
INCLUSO INCLUDED

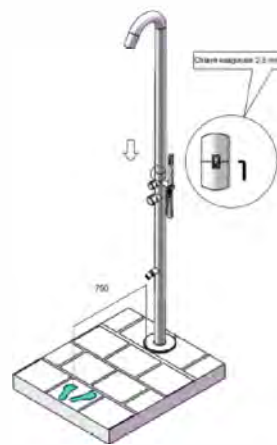
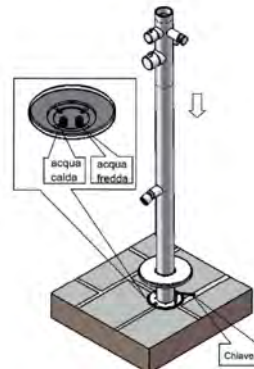
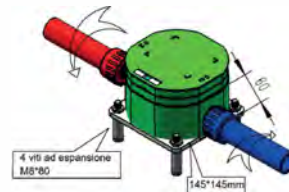

COLLEGAMENTO ACQUA NELLA PARTE INFERIORE.
ACQUA CALDA E FREDDA.
WATER CONNECTION AT THE BOTTOM.
HOT AND COLD WATER.

ACCIAIO INOX 316L
NAUTICO NAUTICAL

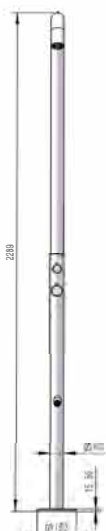
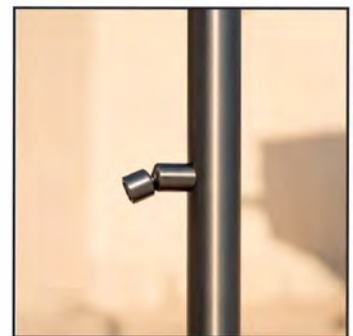
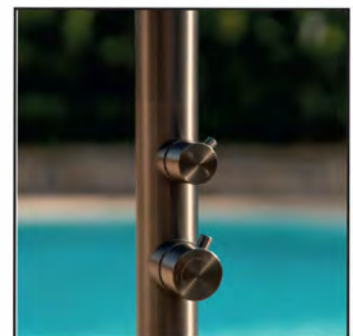
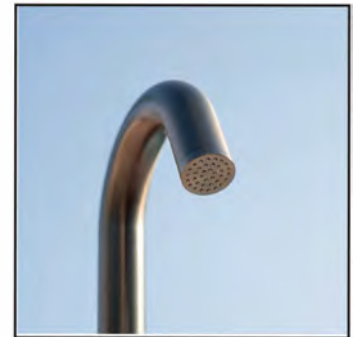

PESO
13,6 KG

COLORE
Canna di fucile

COLLEGAMENTO
acqua calda - acqua fredda

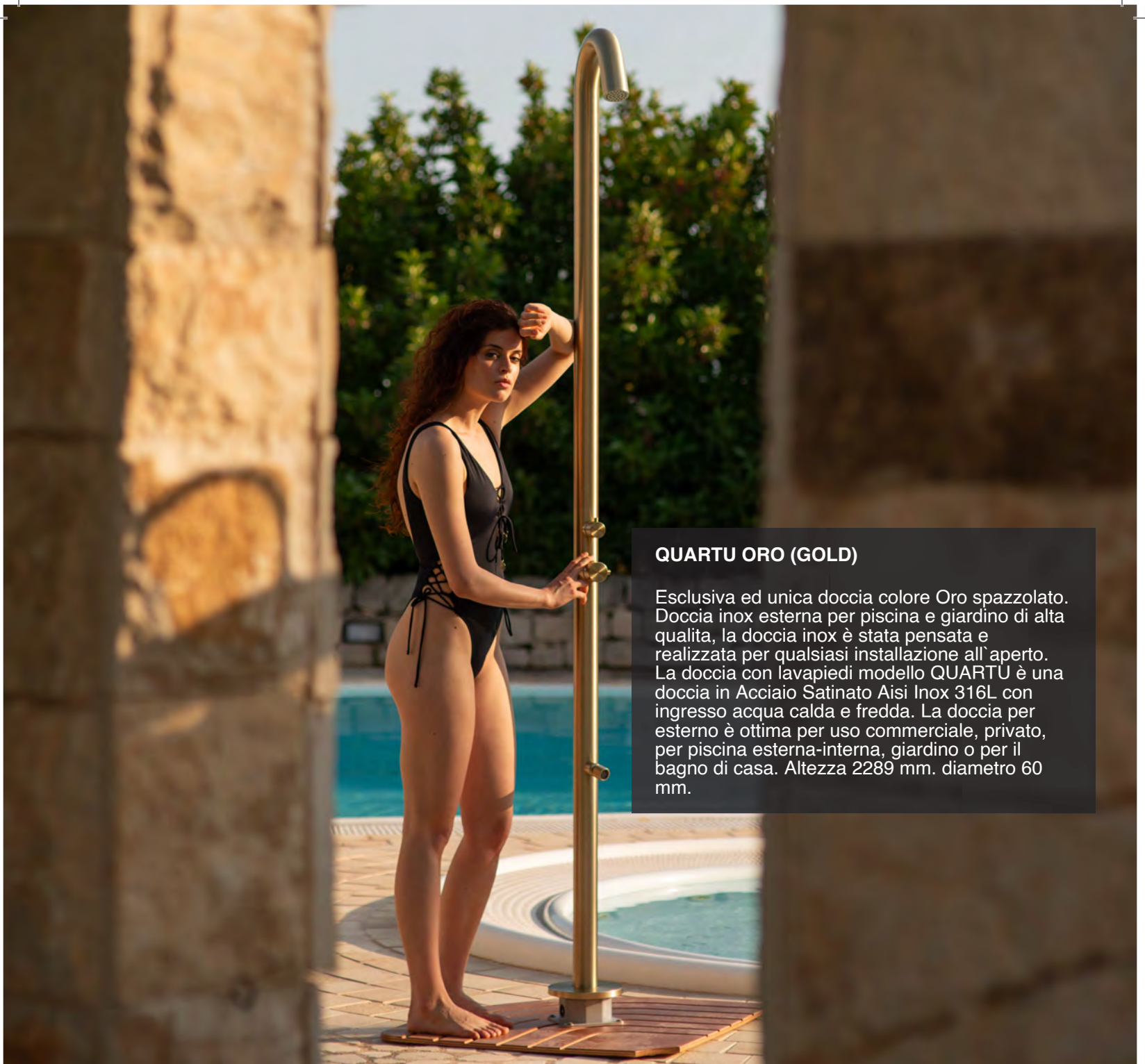

QUARTU ORO (GOLD)

Esclusiva ed unica doccia colore Oro spazzolato. Doccia inox esterna per piscina e giardino di alta qualità, la doccia inox è stata pensata e realizzata per qualsiasi installazione all'aperto. La doccia con lavapiedi modello QUARTU è una doccia in Acciaio Satinato Aisi Inox 316L con ingresso acqua calda e fredda. La doccia per esterno è ottima per uso commerciale, privato, per piscina esterna-interna, giardino o per il bagno di casa. Altezza 2289 mm. diametro 60 mm.

ESPAÑOL

Exclusiva y única ducha de color oro cepillado. Ducha exterior de acero inoxidable de alta calidad para piscina y jardín, la ducha de acero inoxidable está diseñada y fabricada para cualquier instalación exterior. La ducha modelo QUARTU con lavabo de pie es una ducha de acero inoxidable satinado Aisi Inox 316L con entrada de agua caliente y fría. La ducha de exterior es excelente para el uso comercial, privado, en la piscina exterior, en el jardín o en el baño de casa. Altura 2289 mm. diámetro 60 mm.

ENGLISH

Exclusive and unique brushed gold colour shower. High quality stainless steel outdoor shower for pool and garden, the stainless steel shower is designed and manufactured for any outdoor installation. The QUARTU model shower with foot basin is a shower in Satin Stainless Steel Aisi Inox 316L with hot and cold water inlet. The outdoor shower is excellent for commercial, private, outdoor-interior pool, garden or home bathroom use. Height 2289 mm. diameter 60 mm.

FRANÇAIS

Douche exclusive et unique de couleur or brossé. Douche extérieure en acier inoxydable de haute qualité pour piscine et jardin, la douche en acier inoxydable est conçue et fabriquée pour toute installation extérieure. La douche modèle QUARTU avec lave-pieds est une douche en acier inoxydable satiné Aisi Inox 316L avec entrée d'eau chaude et froide. La douche extérieure est excellente pour une utilisation commerciale, privée, dans une piscine extérieure, un jardin ou une salle de bain domestique. Hauteur 2289 mm. Diamètre 60 mm.

DEUTSCH

Exklusive und einzigartige Dusche in gebürstetem Gold. Hochwertige Edelstahl-Außen-dusche für Pool und Garten, die Edelstahldusche ist für jede Außeninstallation konzipiert und hergestellt. Das Modell QUARTU mit Fußwaschbecken ist eine Dusche aus satiniertem Edelstahl Aisi Inox 316L mit Warm- und Kaltwasseranschluss. Die Außendusche eignet sich hervorragend für die gewerbliche, private Nutzung, den Außenpool, den Garten oder das heimische Badezimmer. Höhe 2289 mm. Durchmesser 60 mm.

DOCCIA-QUARTU-ORO

8025431019683

SPECIALE TRATTAMENTO VERNICIATURA PVD
SPECIAL PVD VARNISHING TREATMENT



DIAGONAL RAIN JET



ACQUA CALDA E FREDDA
HOT AND COLD WATER



INCLUDE UNA SACCA DI PROTEZIONE
INCLUDES PROTECTIVE BAG



PUÒ ESSERE FACILMENTE SMONTATA PER L'INVERNO
CAN EASILY BE STORED AT HOME IN THE WINTER



PRODOTTO IN DUE PARTI.
SCATOLA FACILE DA MANEGGIARE (-120CM)
PRODUCT IN TWO PARTS.
EASY TO HANDLE BOX (-120CM)



UGELLI ANTICALCARE
ANTI-SCALE NOZZLES



SISTEMA INSTALLAZIONE C-BOX
INCLUSO INCLUDED

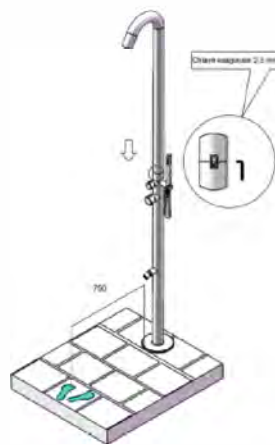
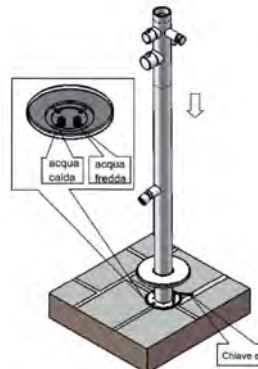
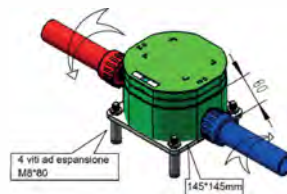

COLLEGAMENTO ACQUA NELLA PARTE INFERIORE.
ACQUA CALDA E FREDDA.
WATER CONNECTION AT THE BOTTOM.
HOT AND COLD WATER.

PESO
13,6 KG

COLORE
Oro

COLLEGAMENTO
acqua calda - acqua fredda

ACCIAIO
INOX 316L
NAUTICO NAUTICAL

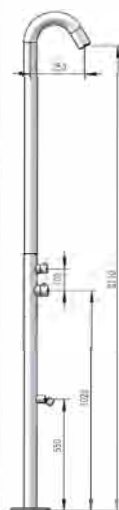
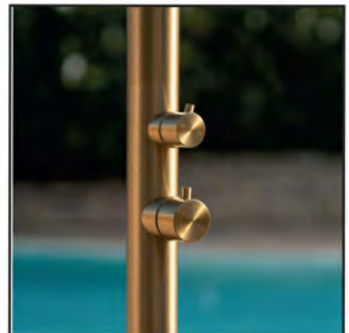

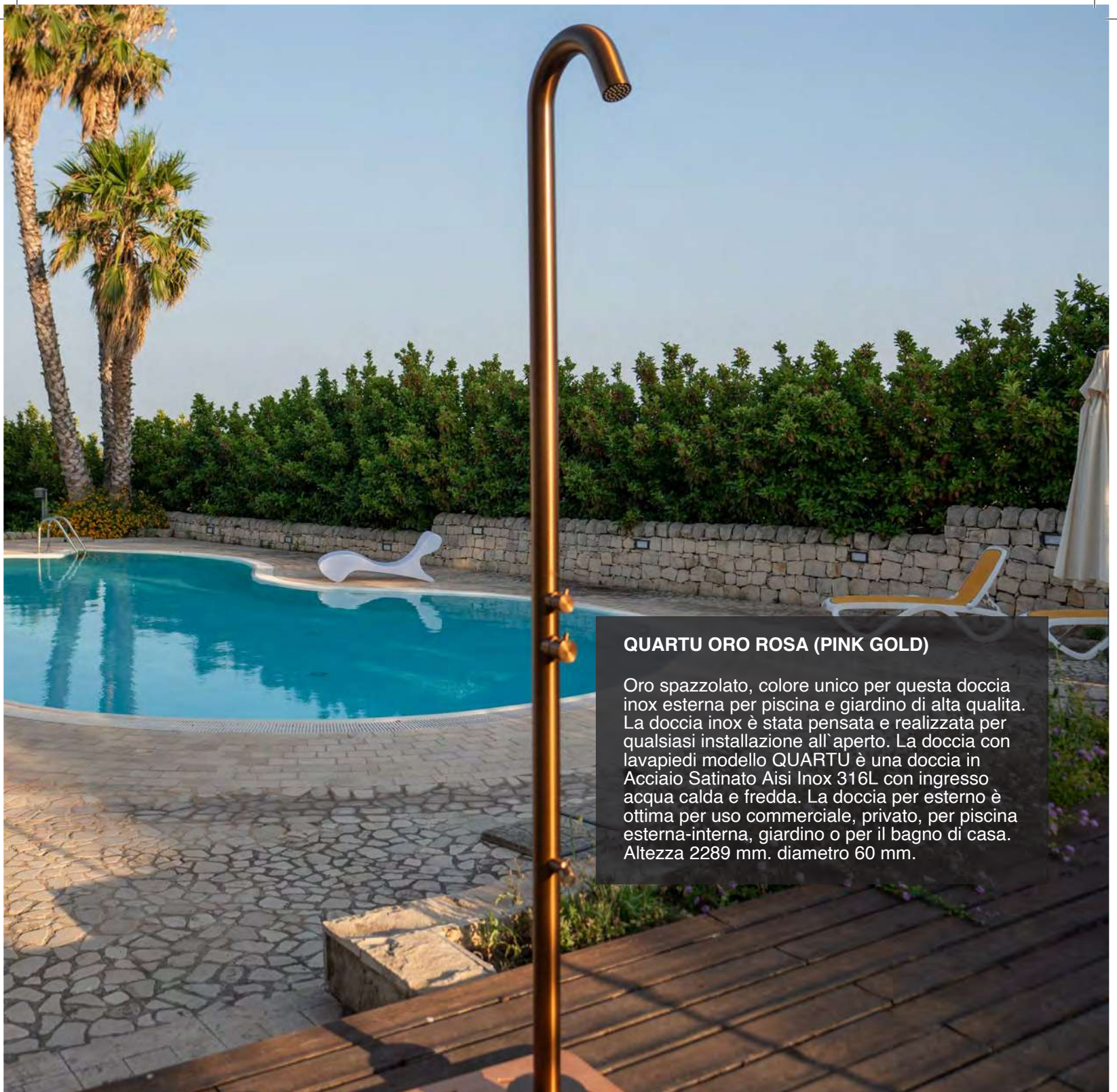

QUARTU ORO ROSA (PINK GOLD)

Oro spazzolato, colore unico per questa doccia inox esterna per piscina e giardino di alta qualità. La doccia inox è stata pensata e realizzata per qualsiasi installazione all'aperto. La doccia con lavapiedi modello QUARTU è una doccia in Acciaio Satinato Aisi Inox 316L con ingresso acqua calda e fredda. La doccia per esterno è ottima per uso commerciale, privato, per piscina esterna-interna, giardino o per il bagno di casa. Altezza 2289 mm. diametro 60 mm.

ESPAÑOL

Oro cepillado, un color único para esta ducha exterior de acero inoxidable de alta calidad para piscina y jardín. La ducha de acero inoxidable está diseñada y fabricada para cualquier instalación exterior. La ducha modelo QUARTU con lavabo de pie es una ducha de acero inoxidable satinado Aisi Inox 316L con entrada de agua caliente y fría. La ducha de exterior es excelente para el uso comercial, privado, en la piscina exterior, en el jardín o en el baño de casa. Altura 2289 mm. diámetro 60 mm.

ENGLISH

Brushed gold, a unique colour for this high-quality stainless steel outdoor shower for pool and garden. The stainless steel shower is designed and manufactured for any outdoor installation. The QUARTU model shower with foot basin is a shower in Satin Stainless Steel Aisi Inox 316L with hot and cold water inlet. The outdoor shower is excellent for commercial, private, outdoor-interior pool, garden or home bathroom use. Height 2289 mm. diameter 60 mm.

FRANÇAIS

L'or brossé, une couleur unique pour cette douche extérieure en acier inoxydable de haute qualité pour la piscine et le jardin. La douche en acier inoxydable est conçue et fabriquée pour toute installation extérieure. La douche modèle QUARTU avec lave-pieds est une douche en acier inoxydable satiné Aisi Inox 316L avec entrée d'eau chaude et froide. La douche extérieure est excellente pour une utilisation commerciale, privée, dans une piscine extérieure, un jardin ou une salle de bain domestique. Hauteur 2289 mm. Diamètre 60 mm.

DEUTSCH

Gebürstetes Gold, eine einzigartige Farbe für diese hochwertige Edelstahl-Außendusche für Pool und Garten. Die Edelstahldusche ist für jede Außeninstallation konzipiert und hergestellt. Das Modell QUARTU mit Fußwaschbecken ist eine Dusche aus satiniertem Edelstahl Aisi Inox 316L mit Warm- und Kaltwasseranschluss. Die Außendusche eignet sich hervorragend für den gewerblichen, privaten Gebrauch, für den Außenpool, den Garten oder das heimische Badezimmer. Höhe 2289 mm. Durchmesser 60 mm.

DOCCIA-QUARTU-ORO-ROSA

8025431019690

SPECIALE TRATTAMENTO VERNICIATURA PVD
SPECIAL PVD VARNISHING TREATMENT



DIAGONAL RAIN JET



ACQUA CALDA E FREDDA
HOT AND COLD WATER



INCLUDE UNA SACCA DI PROTEZIONE
INCLUDES PROTECTIVE BAG



PUÒ ESSERE FACILMENTE SMONTATA PER L'INVERNO
CAN EASILY BE STORED AT HOME IN THE WINTER



PRODOTTO IN DUE PARTI. SCATOLA FACILE DA MANEGGIARE (-120CM)
PRODUCT IN TWO PARTS. EASY TO HANDLE BOX (-120CM)



UGELLI ANTICALCARE
ANTI-SCALE NOZZLES



SISTEMA INSTALLAZIONE C-BOX
INCLUSO INCLUDED

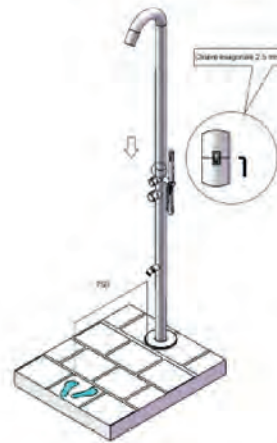
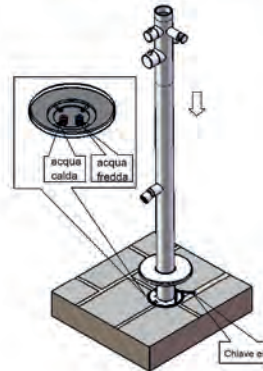
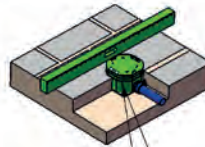
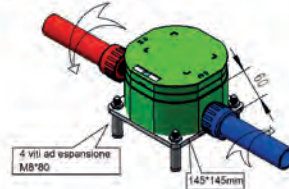

COLLEGAMENTO ACQUA NELLA PARTE INFERIORE.
ACQUA CALDA E FREDDA.
WATER CONNECTION AT THE BOTTOM.
HOT AND COLD WATER.

ACCIAIO INOX 316L
NAUTICO NAUTICAL

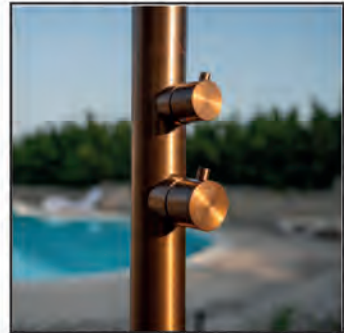

PESO
13,6 KG

COLORE
oro rosa

COLLEGAMENTO
acqua calda - acqua fredda

STINTINO INOX

Doccia classica inox per esterno Sined di alta qualità, la doccia inox è stata pensata e realizzata per qualsiasi installazione all'aperto. La doccia con doccino modello STINTINO INOX è una doccia in Acciaio Satinato Aisi Inox 316L con ingresso acqua calda e fredda. La doccia per esterno è ottima per uso commerciale, privato, per piscina esterna-interna, giardino, per il bagno di casa, SPA o TERME. Altezza 2280 mm. diametro 60 mm.

- Miscelatore, permette di avere acqua calda dal soffione dal lavapièdi e dal doccino mobile.
- Attacchi acqua a scomparsa sulla base.
- Rubinetteria in Acciaio Aisi 316L.
- Collegamento acqua dal basso con attacchi rapidi.
- Flessibile del doccino in acciaio inox AISI 304

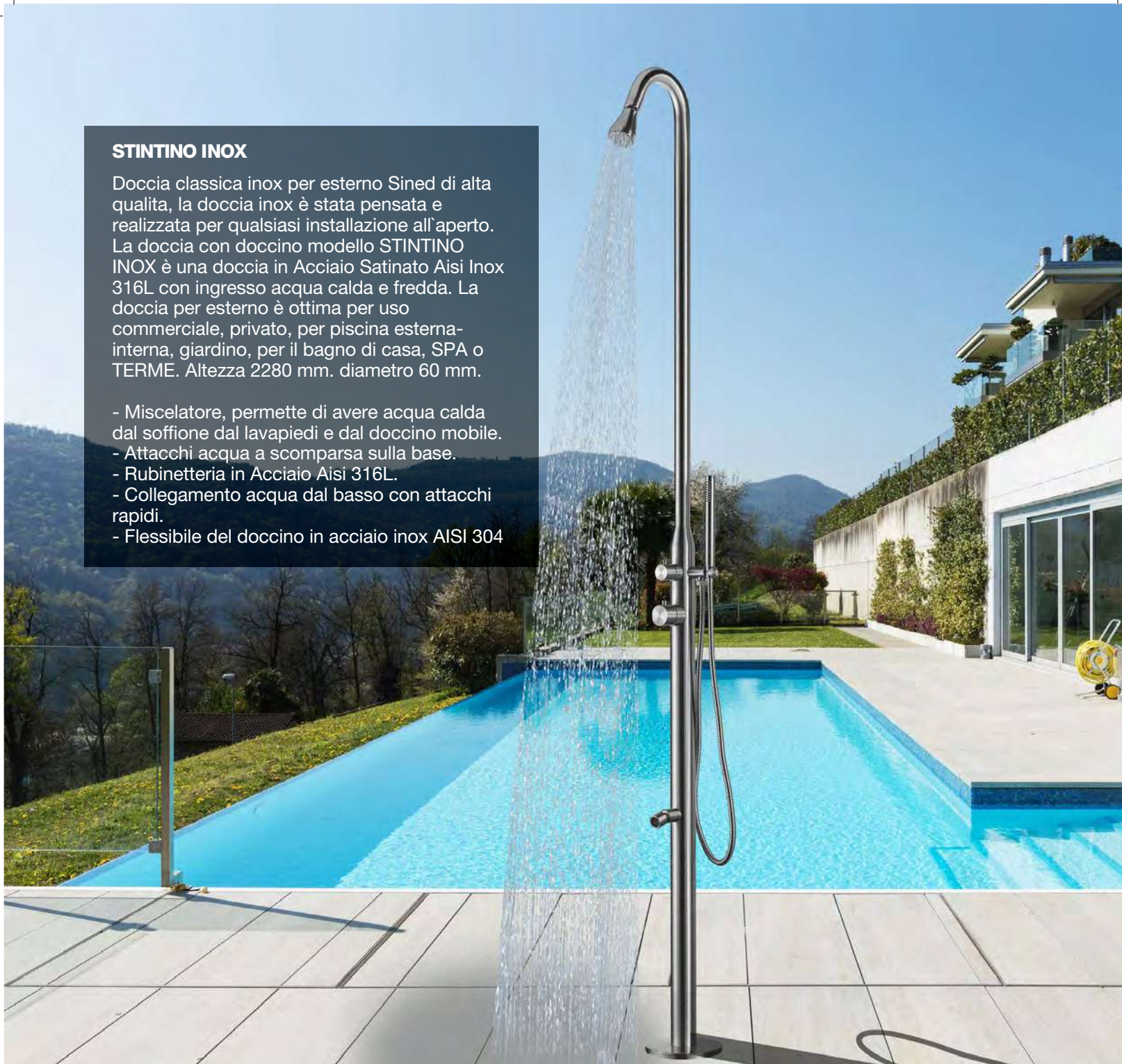

DEUTSCH

Klassische Edelstahl-Dusche für den Außenbereich. Die Edelstahl-Dusche ist von hoher Qualität und wurde für jede Außeninstallation entworfen und hergestellt. Die Dusche mit Handbrause Modell STINTINO INOX ist eine Dusche aus satiniertem Edelstahl Aisi Inox 316L mit Warm- und Kaltwasseranschluss.

- Mischbatterie, die es ermöglicht, warmes Wasser von der Kopfbrause, vom Fußwaschhahn und von der Handbrause zu haben.
- Verdeckte Wasseranschlüsse auf der Basis.
- Aisi 316L Stahlarmaturen.
- Wasseranschluss von unten mit Schnellkupplungen.
- Handbrauseschlauch aus Edelstahl AISI 304

FRANÇAIS

Douche classique en acier inoxydable pour usage extérieur. Sinede haute qualité, la douche en acier inoxydable est conçue et fabriquée pour toute installation extérieure. La douche avec douchette modèle STINTINO INOX est une douche en acier inoxydable satiné Aisi Inox 316L avec arrivée d'eau chaude et froide.

- Mélangeur, il permet d'avoir de l'eau chaude de la pomme de douche du lave-pièdi et de la douche mobile.
- Raccordements d'eau encastrés sur la base.
- Robinets en acier Aisi 316L.
- Raccordement d'eau par le bas avec raccords rapides.
- Flexible de douche à main en acier inoxydable AISI 304

ENGLISH

Classic stainless steel shower for outdoor use. Sined of high quality, the stainless steel shower is designed and manufactured for any outdoor installation. The shower with hand shower model STINTINO INOX is a shower in Satin Stainless Steel Aisi Inox 316L with hot and cold water inlet.

- Mixer, it allows to have hot water from the shower head from the footwash and from the mobile shower.
- Concealed water connections on the base.
- Taps in Aisi 316L Steel.
- Water connection from the bottom with quick couplings.
- AISI 304 stainless steel hand shower hose

ESPAÑOL

Ducha clásica de acero inoxidable para exteriores. Sined de alta calidad, la ducha de acero inoxidable está diseñada y fabricada para cualquier instalación exterior. La ducha con teleducha modelo STINTINO INOX es una ducha de acero inoxidable satinado Aisi Inox 316L con entrada de agua caliente y fría.

- Mezclador, permite disponer de agua caliente de la alcachofa de la ducha del lavapiés y de la ducha móvil.
- Conexiones de agua ocultas en la base.
- Grifos de acero Aisi 316L.
- Conexión de agua por la parte inferior con acoples rápidos.
- Manguera de ducha manual de acero inoxidable AISI 304

DOCCIA-STINTINO-INOX

8025431016774



DIAGONAL
RAIN JET



ACQUA CALDA E
FREDDA
HOT AND COLD WATER



INCLUDE UNA SACCA
DI PROTEZIONE
INCLUDES PROTECTIVE
BAG



PUÒ ESSERE
FACILMENTE
SMONTATA PER
L'INVERNO
CAN EASILY BE STORED
AT HOME IN THE WINTER



PRODOTTO IN DUE PARTI.
SCATOLA FACILE DA
MANEGGIARE (-120CM)
PRODUCT IN TWO PARTS.
EASY TO HANDLE BOX
(-120CM)



UGELLI ANTICALCARE
ANTI-SCALE NOZZLES



SISTEMA
INSTALLAZIONE C-BOX
INCLUSO INCLUDED

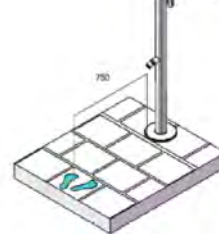
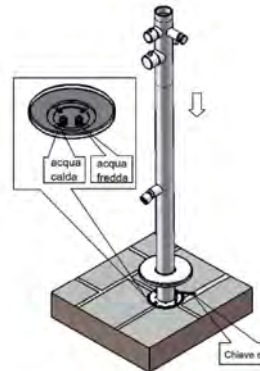
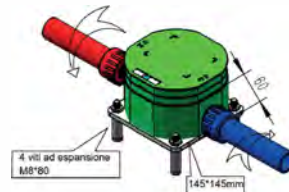

COLLEGAMENTO ACQUA NELLA
PARTE INFERIORE.
ACQUA CALDA E FREDDA.
WATER CONNECTION AT THE
BOTTOM.
HOT AND COLD WATER.

ACCIAIO
INOX 316L
NAUTICO NAUTICAL

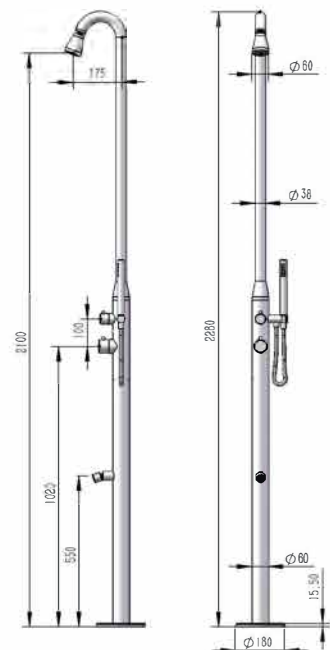

PESO
13,6 Kg

COLORE
Inox satinato

COLLEGAMENTO
acqua calda - acqua fredda



STINTINO NERA

Doccia da esterno in Acciaio Inox Nero Sinedi di alta qualità, la doccia inox è stata pensata e realizzata per qualsiasi installazione all'aperto. La doccia con doccino modello STINTINO NERA è una doccia in Acciaio Satinato Aisi Inox 316L con ingresso acqua calda e fredda. La doccia per esterno è ottima per uso commerciale, privato, per piscina esterna-interna, giardino, bagno di casa, SPA o TERME. Altezza 2280 mm. diametro 60 mm.

- Miscelatore, permette di avere acqua calda dal soffione dal lavapiedi e dal doccino mobile.
- Attacchi acqua a scomparsa sulla base.
- Rubinetteria in Acciaio Aisi 316L.
- Collegamento acqua dal basso con attacchi rapidi.
- Flessibile del doccino in acciaio inox AISI 304

DEUTSCH

Die hochwertige Außendusche aus schwarzem satiniertem Edelstahl wurde für jede Außeninstallation entworfen und hergestellt. Die Dusche mit Handbrause Modell STINTINO NERA ist eine Dusche aus satiniertem Edelstahl Aisi Inox 316L mit Warm- und Kaltwasseranschluss.

- Mischbatterie, die es ermöglicht, warmes Wasser von der Kopfbrause, vom Fußwaschhahn und von der Handbrause zu haben.
- Verdeckte Wasseranschlüsse auf der Basis.
- Aisi 316L Stahlarmaturen.
- Wasseranschluss von unten mit Schnellkupplungen.
- Handbrauseschlauch aus Edelstahl AISI 304

FRANÇAIS

La douche d'extérieur en acier inoxydable noir satiné de haute qualité est conçue et fabriquée pour toute installation extérieure. La douche avec douchette modèle STINTINO NERA est une douche en acier inoxydable Aisi Inox 316L avec arrivée d'eau chaude et froide.

- Mélangeur, il permet d'avoir de l'eau chaude de la pomme de douche du lave-pieds et de la douchette mobile.
- Raccordements d'eau encastrés sur la base.
- Robinets en acier Aisi 316L.
- Raccordement d'eau par le bas avec raccords rapides.
- Flexible de douche à main en acier inoxydable AISI 304

ENGLISH

High-quality Sined Black Stainless Steel outdoor shower is designed and manufactured for any outdoor installation. The shower with hand shower model STINTINO NERA is a shower in Satin Stainless Steel Aisi Inox 316L with hot and cold water inlet.

- Mixer, it allows to have hot water from the shower head from the footwash and from the mobile shower.
- Concealed water connections on the base.
- Taps in Aisi 316L Steel.
- Water connection from the bottom with quick couplings.
- AISI 304 stainless steel hand shower hose

ESPAÑOL

La ducha de exterior de Acero Inoxidable Negro Sinedizado de alta calidad está diseñada y fabricada para cualquier instalación exterior. La ducha con teleducha modelo STINTINO NERA es una ducha en Acero Inoxidable Satinado Aisi Inox 316L con entrada de agua caliente y fría.

- Mezclador, permite disponer de agua caliente del cabezal de la ducha del lavapiés y de la ducha móvil.
- Conexiones de agua ocultas en la base.
- Grifos de acero Aisi 316L.
- Conexión de agua por la parte inferior con acoples rápidos.
- Manguera de ducha manual de acero inoxidable AISI 304

DOCCIA-STINTINO-NERA

8025431016842



DIAGONAL
RAIN JET



ACQUA CALDA E
FREDDA
HOT AND COLD WATER



INCLUDE UNA SACCA
DI PROTEZIONE
INCLUDES PROTECTIVE
BAG



PUÒ ESSERE
FACILMENTE
SMONTATA PER
L'INVERNO
CAN EASILY BE STORED
AT HOME IN THE WINTER



PRODOTTO IN DUE PARTI.
SCATOLA FACILE DA
MANEGGIARE (-120CM)
PRODUCT IN TWO PARTS.
EASY TO HANDLE BOX
(-120CM)



UGELLI ANTICALCARE
ANTI-SCALE NOZZLES



SISTEMA
INSTALLAZIONE C-BOX
INCLUSO INCLUDED

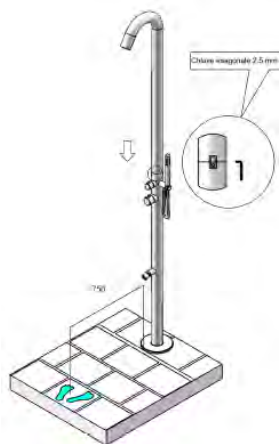
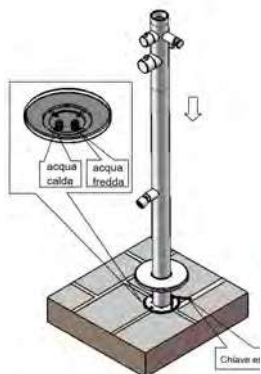
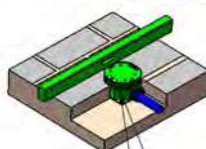
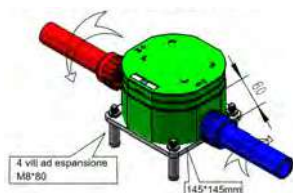

COLLEGAMENTO ACQUA NELLA
PARTE INFERIORE.
ACQUA CALDA E FREDDA.
WATER CONNECTION AT THE
BOTTOM.
HOT AND COLD WATER.

PESO

13,6 Kg

COLORE

Nero satinato Matt Black

COLLEGAMENTO

acqua calda - acqua fredda

ACCIAIO

INOX 316L

NAUTICO NAUTICAL

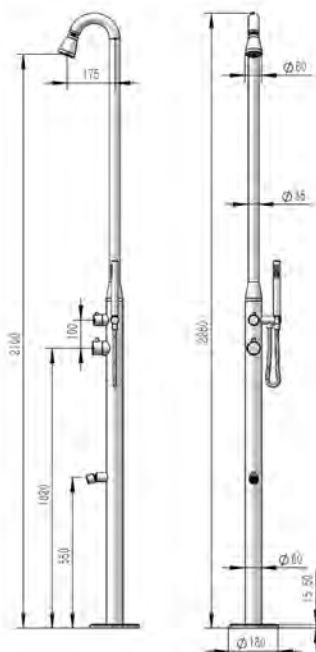



SASSARI INOX

La doccia con doccino modello SASSARI INOX è una doccia in Acciaio Satinato Aisi Inox 316L con ingresso acqua calda e fredda. La doccia per esterno è ottima per uso commerciale, privato, per piscina esterna-interna, giardino o per il bagno di casa. Altezza 230 cm. diametro 60 mm.

- Miscelatore, permette di avere acqua calda dal soffione e dal doccino mobile.
- Attacchi acqua a scomparsa sulla base.
- Rubinetteria in Acciaio Aisi 316L.
- Collegamento acqua dal basso con attacchi rapidi.
- Flessibile del doccino in acciaio inox AISI 304
- Utilizza uno speciale aeratore che non genera schizzi, scelta tecnica per chi vuole un getto diretto e non gli spruzzi.

DEUTSCH

Außendusche Sassari aus satiniertem Edelstahl Gartendusche mit Warm- und Kaltwasserzulauf Handbrause und Mischer Körper aus Edelstahl AISI

- Höhe 230 cm Durchmesser 60mm.
- Mischbatterie, ermöglicht warmes Wasser von der Kopfbrause und von der mobilen Handbrause.
- Verdeckte Wasseranschlüsse an der Basis.
- Armaturen aus Aisi 316L Edelstahl
- Wasseranschluss von unten mit Schnellkupplungen
- Handbrauseschlauch aus Edelstahl AISI 304
- Er verwendet einen speziellen Luftsprudler, der keine Spritzer erzeugt, eine technische Wahl für diejenigen, die einen direkten Strahl und keine Spritzer wünschen.

FRANÇAIS

Douche intérieure et extérieure SASSARI en acier inoxydable AISI 316L satiné. Hauteur 230 cm. Diamètre 60 mm.

- Mélangeur, permet d'avoir de l'eau chaude à partir de la pomme de douche et de la douchette mobile.
- Raccordements d'eau encastrés sur la base.
- Robinets en acier Aisi 316L.
- Raccordement d'eau par le bas avec des raccords rapides.
- Flexible de douche à main en acier inoxydable AISI 304
- Il utilise un aérateur spécial qui ne génère pas d'éclaboussures, un choix technique pour ceux qui veulent un jet direct et non des éclaboussures.

ENGLISH

The outdoor shower is excellent for commercial, private, outdoor-interior pool, garden or home bathroom use. Height 230 cm. diameter 60 mm.

- Mixer, it allows to have hot water from the shower head and from the mobile hand shower.
- Concealed water connections on the base.
- Taps in Aisi 316L Steel.
- Water connection from the bottom with quick couplings.
- AISI 304 stainless steel hand shower hose
- It uses a special aerator that does not generate splashes, a technical choice for those who want a direct jet and not sprays.

ESPAÑOL

Ducha de interior y exterior SASSARI de acero inoxidable satinado AISI 316L. Con ducha superior integrada y ducha de mano. Conexiones ocultas en la base gracias a la C-Box.

- Altura 230cm. Diámetro 60mm.
- Mezclador, permite disponer de agua caliente desde el cabezal de la ducha y desde la teleducha móvil.
- Conexiones de agua ocultas en la base.
- Grifos en acero Aisi 316L.
- Conexión de agua por la parte inferior con acoples rápidos.
- Manguera de ducha manual de acero inoxidable AISI 304
- Utiliza un aireador especial que no genera salpicaduras, una opción técnica para quienes desean un chorro directo.

DOCCIA-SASSARI-INOX

8025431016750

ACCIAIO
INOX 316L
NAUTICO NAUTICAL



CONTINUOUS
RAIN JET



ACQUA CALDA E
FREDDA
HOT AND COLD WATER



INCLUDE UNA SACCA
DI PROTEZIONE
INCLUDES PROTECTIVE
BAG



PUÒ ESSERE
FACILMENTE
SMONTATA PER
L'INVERNO
CAN EASILY BE STORED
AT HOME IN THE WINTER



PRODOTTO IN DUE PARTI.
SCATOLA FACILE DA
MANEGGIARE (-120CM)
PRODUCT IN TWO PARTS.
EASY TO HANDLE BOX
(-120CM)



UGELLI ANTICALCARE
ANTI-SCALE NOZZLES



SISTEMA
INSTALLAZIONE C-BOX
INCLUSO INCLUDED

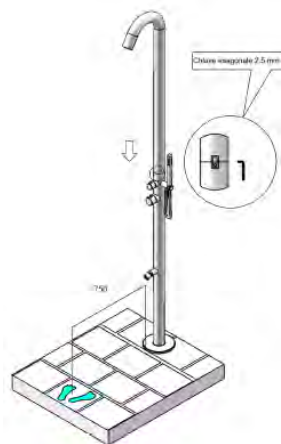
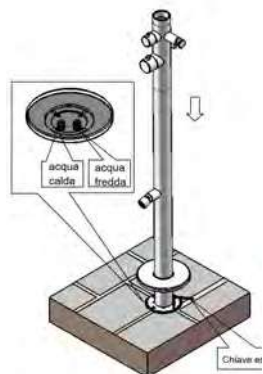
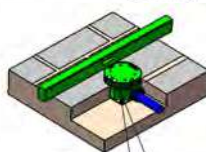
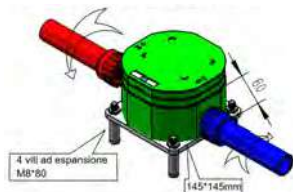

COLLEGAMENTO ACQUA NELLA
PARTE INFERIORE.
ACQUA CALDA E FREDDA.
WATER CONNECTION AT THE
BOTTOM.
HOT AND COLD WATER.

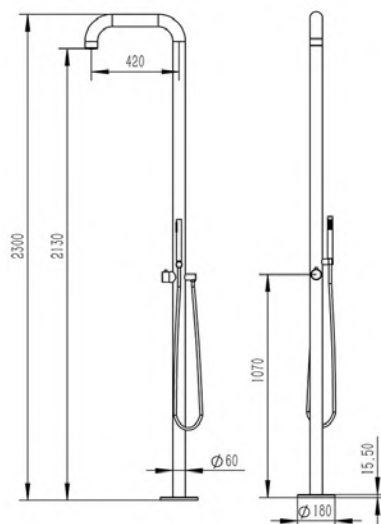

PESO
9,3 Kg

COLORE
Inox satinato

COLLEGAMENTO
acqua calda - acqua fredda

SIMIUS INOX

Doccia classica per piscina Sined di alta qualità solo acqua fredda, la doccia Simius inox è stata pensata e realizzata per qualsiasi installazione all'aperto. La doccia modello SIMIUS INOX è una

doccia in Acciaio Satinato Aisi Inox 316L con ingresso acqua solo fredda. La doccia per esterno è ottima per uso commerciale, privato, per piscina esterna-interna, giardino o per il bagno di casa. Altezza 230 cm. diametro 38 mm.

- Solo acqua fredda.
- Rubinetteria in Acciaio Aisi 316L.
- Collegamento acqua laterale solo acqua fredda attacco std mezzo pollice.
- La base rotonda antiribaltamento è molto larga e permette di appoggiare la doccia sul pavimento senza bisogno di fissarla con dei tasselli



DEUTSCH

Hochwertige klassische Dusche für Schwimmbäder Nur mit kaltem Wasser gespeist, wurde die Edelstahl-dusche Simius für jede Außeninstallation entworfen und hergestellt. Das Duschmodell SIMIUS INOX ist eine Dusche aus satiniertem Edelstahl Aisi Inox 316L ausschließlich mit Kaltwasseranschluss.

- Nur Kaltwasser.
- Wasserhähne aus rostfreiem Stahl Aisi 316L.
- Seitlicher Wasseranschluss nur Kaltwasser std halben Zoll-Anschluss.
- Der runde Sockel ist sehr breit und ermöglicht es, die Dusche auf den Boden zu stellen, ohne dass sie mit Dübeln befestigt werden muss

FRANÇAIS

Douche classique de haute qualité pour piscine Sillonnée uniquement d'eau froide, la douche en acier inoxydable a été conçue et fabriquée pour toute installation extérieure. Le modèle de douche SIMIUS INOX est une douche en acier inoxydable satiné Aisi Inox 316L avec entrée d'eau froide uniquement.

- Eau froide uniquement.
- Robinets en acier inoxydable Aisi 316L.
- Raccordement latéral à l'eau froide uniquement, raccord standard d'un demi-pouce.
- La base ronde est très large et permet de poser la douche sur le sol sans avoir besoin de la fixer avec des chevilles.

ENGLISH

Classic shower for swimming pool Sined of high quality only cold water, the stainless steel shower has been thought and realized for any outdoor installation. The shower model SIMIUS INOX is a shower in Satin Stainless Steel Aisi Inox 316L with only cold water inlet. Height 230 cm. diameter 38 mm.

- Cold water only.
- Aisi 316L stainless steel taps.
- Lateral water connection cold water only std half inch connection.
- The round base is very wide and allows the shower to be placed on the floor without the need to fix it with dowels

ESPAÑOL

Ducha clásica de alta calidad para piscina Sined sólo agua fría, la ducha de acero inoxidable ha sido diseñada y fabricada para cualquier instalación exterior. El modelo de ducha SIMIUS INOX es una ducha de acero inoxidable satinado Aisi Inox 316L con entrada de agua fría únicamente.. Altura 230 cm. diámetro 38 mm.

- Sólo agua fría.
- Grifos de acero inoxidable Aisi 316L.
- Conexión lateral de agua fría sólo conexión estándar de media pulgada..
- La base redonda es muy ancha y permite colocar la ducha en el suelo sin necesidad de fijarla con tacos

DOCCIA-SIMIUS-INOX

8025431016767



INCLUDE UNA SACCA
DI PROTEZIONE
INCLUDES PROTECTIVE
BAG



PUÒ ESSERE
FACILMENTE
SMONTATA PER
L'INVERNO
CAN EASILY BE STORED
AT HOME IN THE WINTER



PRODOTTO IN DUE PARTI.
SCATOLA FACILE DA
MANEGGIARE (-120CM)
PRODUCT IN TWO PARTS.
EASY TO HANDLE BOX
(-120CM)



UGELLI ANTICALCARE
ANTI-SCALE NOZZLES

BASE LARGA (55 CM)
NON SONO NECESSARIE
VITI O INSTALLAZIONI FISSE

WIDE BASE (55CM)
NON SONO NECESSARIE
VITI O INSTALLAZIONI
FISSE

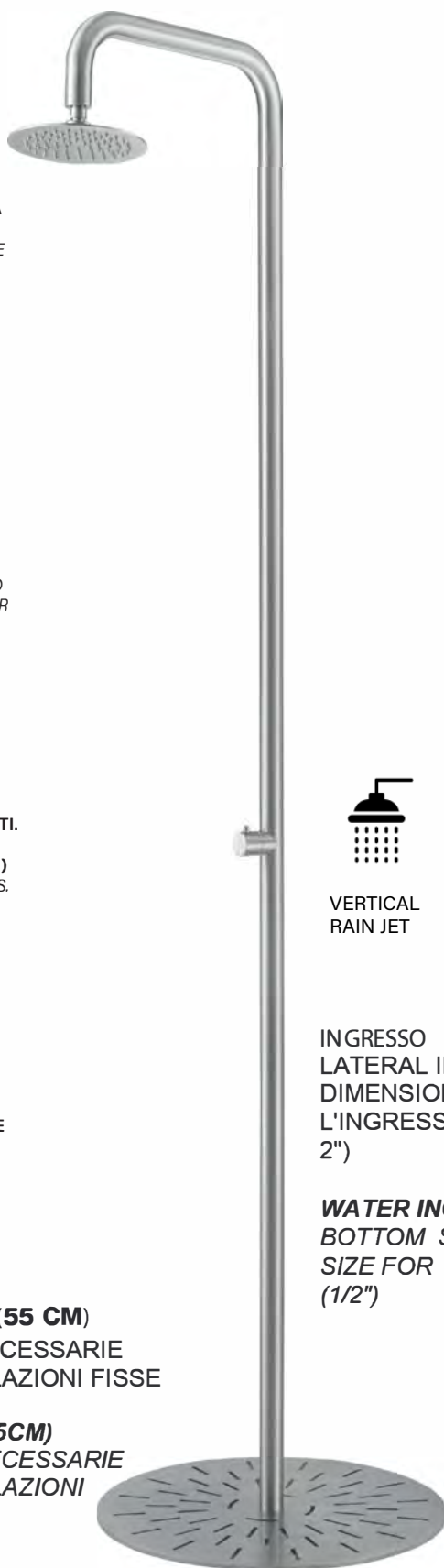

COLLEGAMENTO ACQUA
LATERALE 1/2"
SIDE WATER CONNECTION



SOLO ACQUA FREDDA
COLD WATER ONLY



VERTICAL
RAIN JET

INGRESSO DI ACQUA
LATERAL INFERIORE.
DIMENSIONE STANDARD PER
L'INGRESSO DELL'ACQUA (1/
2")

**WATER INGRESS AT THE
BOTTOM SIDE. STANDARD
SIZE FOR WATER INLET
(1/2")**

PESO
18,9 kg

COLORE
Inox satinato

COLLEGAMENTO
acqua fredda

ACCIAIO
INOX 316L
NAUTICO NAUTICAL

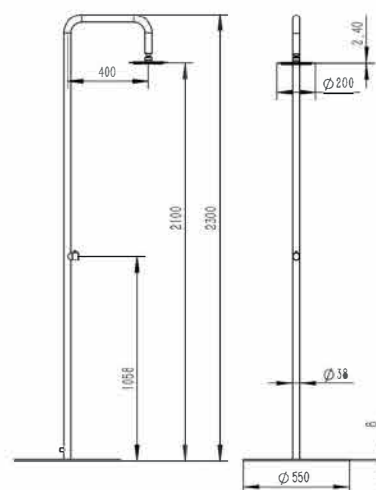



ARBOREA INOX

Novità assoluta è la doccia esterna a muro sined Arborea, posizionabile con 3 punti di fissaggio a parete. Realizzata in ottimo acciaio inox AISI 316L (acciaio inox marino) è stata pensata per tutte le attività che hanno poco spazio per la installazione a terra di una doccia. Studiata per grandi carichi di lavoro è ideale per tutte le attività all'aperto o per il Bagno. Ottima per uso interno anche nel bagno di casa.

- La doccia per parete modello Arborea è una doccia in Acciaio Satinato Aisi Inox 316L con Fusto diametro 60 mm
- Doppio ingresso acqua calda e fredda
- Speciale Miscelatore progressivo con deviatore incorporato e cartuccia a 3 vie, permette di controllare la temperatura dell'acqua calda dal soffione e dalla doccetta a mano.
- Doccetta a mano
- Rubinetteria in Acciaio Aisi 316L.
- Flessibile del doccino in acciaio inox AISI 304
- Attacchi acqua a scomparsa nel muro

DEUTSCH

Eine absolute Neuheit ist die wandmontierte Außendusche, die mit 3 Befestigungspunkten an der Wand montiert werden kann. Die Wanddusche Arborea ist aus hochwertigem Edelstahl AISI 316L (Marine-Edelstahl).

- Das wandmontierte Duschmodell Arborea ist eine Dusche aus satiniertem Edelstahl Aisi Inox 316L mit einem Schaft von 60 mm Durchmesser.
- Doppelter Warm- und Kaltwasserzulauf - Mischbatterie mit 3-Wege-Kartusche.
- Mobile Handbrause
- Armaturen aus rostfreiem Stahl Aisi 316L - Handbrauseschlauch aus Edelstahl AISI 304
- Verdeckte Wasseranschlüsse - Progressiver Mischer mit eingebautem Umsteller

FRANÇAIS

La nouveauté absolue est la douche extérieure murale, qui peut être positionnée avec 3 points de fixation sur le mur. Fabriquée en acier inoxydable AISI 316L de haute qualité (acier inoxydable marin), elle a été conçue pour toutes les activités où il y a peu d'espace pour installer une douche au sol.

- La douche murale modèle Arborea est une douche en acier inoxydable satiné Aisi Inox 316L avec une tige de 60 mm de diamètre.
- Double entrée d'eau chaude et froide - Mélangeur avec cartouche à 3 voies
- Douche à main - Robinetterie en acier inoxydable Aisi 316L.
- Flexible de douche à main en acier inoxydable AISI 304
- Raccordements d'eau dissimulés
- Mélangeur progressif avec déviateur intégré

ENGLISH

Absolute novelty is the wall-mounted outdoor shower, which can be positioned with 3 fixing points on the wall. Made of high quality AISI 316L stainless steel (marine stainless steel), it has been designed for all activities where there is little space to install a shower on the ground.

- The wall mounted shower model Arborea is a shower in Satin Stainless Steel Aisi Inox 316L with a 60 mm diameter shaft.
- Double hot and cold water inlet - Mixer with 3-way cartridge
- Hand shower - Aisi 316L stainless steel tapware.
- AISI 304 stainless steel hand shower hose
- Concealed water connections
- Progressive mixer with built-in diverter

ESPAÑOL

La novedad absoluta es la ducha exterior montada en la pared Sined Arborea, que puede colocarse con 3 puntos de fijación en la pared. Fabricado en acero inoxidable AISI 316L (acero inoxidable marino) de alta calidad, ha sido diseñado para todas las actividades en las que hay poco espacio para instalar una ducha en el suelo.

- La ducha mural modelo Arborea es una ducha de acero inoxidable satinado Aisi Inox 316L con un eje de 60 mm de diámetro.
- Doble entrada de agua caliente y fría
- Mezclador con cartucho de 3 vías.
- Ducha de mano - Grifería de acero inoxidable Aisi 316L.
- Manguera de ducha manual de acero inoxidable AISI 304
- Conexiones de agua ocultas
- Mezclador progresivo con desviador incorporado

DOCCIA-ARBOREA-INOX

8025431018600

CON FISSAGGIO A MURO

ACCIAIO
INOX 316L

NAUTICO NAUTICAL

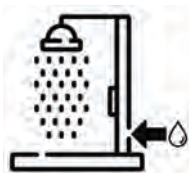
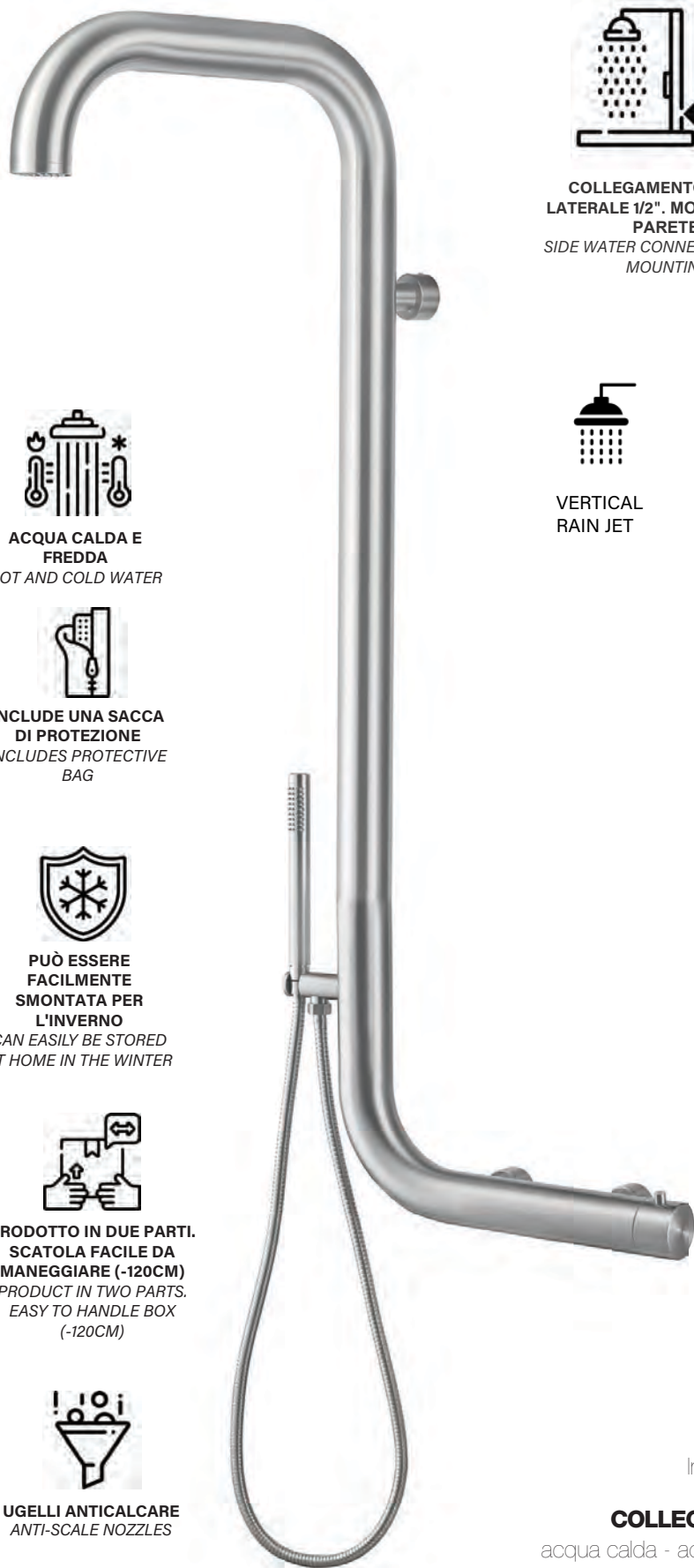

COLLEGAMENTO ACQUA
LATERALE 1/2". MONTAGGIO A
PARETE.
SIDE WATER CONNECTION. WALL
MOUNTING



VERTICAL
RAIN JET



ACQUA CALDA E
FREDDA
HOT AND COLD WATER



INCLUDE UNA SACCA
DI PROTEZIONE
INCLUDES PROTECTIVE
BAG



PUÒ ESSERE
FACILMENTE
SMONTATA PER
L'INVERNO
CAN EASILY BE STORED
AT HOME IN THE WINTER



PRODOTTO IN DUE PARTI.
SCATOLA FACILE DA
MANEGGIARE (-120CM)
PRODUCT IN TWO PARTS.
EASY TO HANDLE BOX
(-120CM)



UGELLI ANTICALCARE
ANTI-SCALE NOZZLES

PESO

8,2 kg

COLORE

Inox satinato

COLLEGAMENTO

acqua calda - acqua fredda

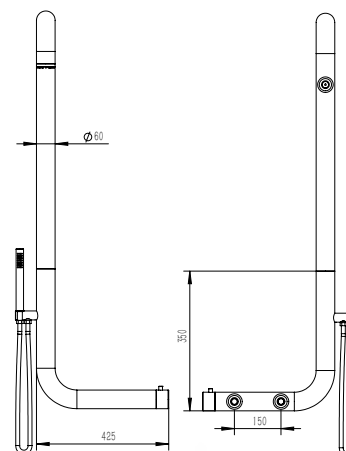
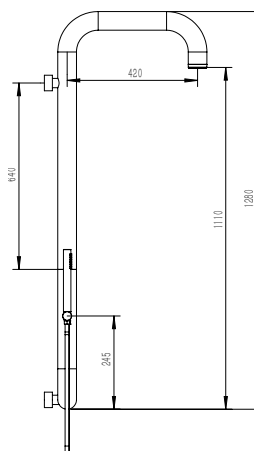



ARBOREA NERA

Parete doccia con profilo in acciaio inox colore nero, accessoriata dell'utile doccino mobile per il massimo comfort. La doccia esterna a muro SINED Arborea, posizionabile con 3 punti di fissaggio a parete. Realizzata in ottimo acciaio inox AISI 316L (acciaio inox marino) è stata pensata per tutte le attività che hanno poco spazio per la installazione a terra di una doccia. Studiata per grandi carichi di lavoro è ideale per tutte le attività all'aperto o per il Bagno. Ottima per uso interno anche nel bagno di casa.

ESPAÑOL

Panel de ducha con perfil de acero inoxidable negro, equipado con la útil teleducha móvil para el máximo confort. La ducha mural de exterior SINED Arborea puede colocarse con 3 puntos de fijación en la pared. Fabricada en excelente acero inoxidable AISI 316L (acero inoxidable de calidad marina), está diseñada para todas las actividades que disponen de poco espacio para la instalación de una ducha en el suelo. Diseñada para grandes cargas de trabajo, es ideal para todas las actividades al aire libre o para el cuarto de baño. También es excelente para uso interior en el cuarto de baño de casa.

ENGLISH

Shower panel with black stainless steel profile, equipped with the useful mobile hand shower for maximum comfort. The SINED Arborea wall-mounted outdoor shower can be positioned with 3 fixing points on the wall. Made of excellent AISI 316L stainless steel (marine grade stainless steel), it is designed for all activities that have little space for the installation of a shower on the floor. Designed for large workloads, it is ideal for all outdoor activities or for the bathroom. Also excellent for indoor use in the bathroom at home.

FRANÇAIS

Panneau de douche avec profilé en acier inoxydable noir, équipé de l'utile douchette mobile pour un confort maximal. La douche extérieure murale SINED Arborea peut être positionnée grâce à 3 points de fixation sur le mur. Fabriquée en acier inoxydable AISI 316L (acier inoxydable de qualité marine), elle est conçue pour toutes les activités qui disposent de peu d'espace pour l'installation d'une douche au sol. Conçu pour les grandes charges de travail, il est idéal pour toutes les activités de plein air ou pour la salle de bains. Elle est également excellente pour une utilisation intérieure dans la salle de bains de la maison.

DEUTSCH

Duschpaneel mit schwarzem Edelstahlprofil, ausgestattet mit der praktischen mobilen Handbrause für maximalen Komfort. Die wandmontierte Außendusche SINED Arborea kann mit 3 Befestigungspunkten an der Wand positioniert werden. Sie ist aus hochwertigem Edelstahl AISI 316L (Edelstahl in Marinequalität) gefertigt und wurde für alle Aktivitäten entwickelt, bei denen nur wenig Platz für die Installation einer Dusche auf dem Boden vorhanden ist. Er ist für hohe Arbeitslasten ausgelegt und eignet sich ideal für alle Aktivitäten im Freien oder im Badezimmer.

DOCCIA-ARBOREA-NERA

8025431150935

CON FISSAGGIO A MURO

ACCIAIO

INOX 316L

NAUTICO NAUTICAL

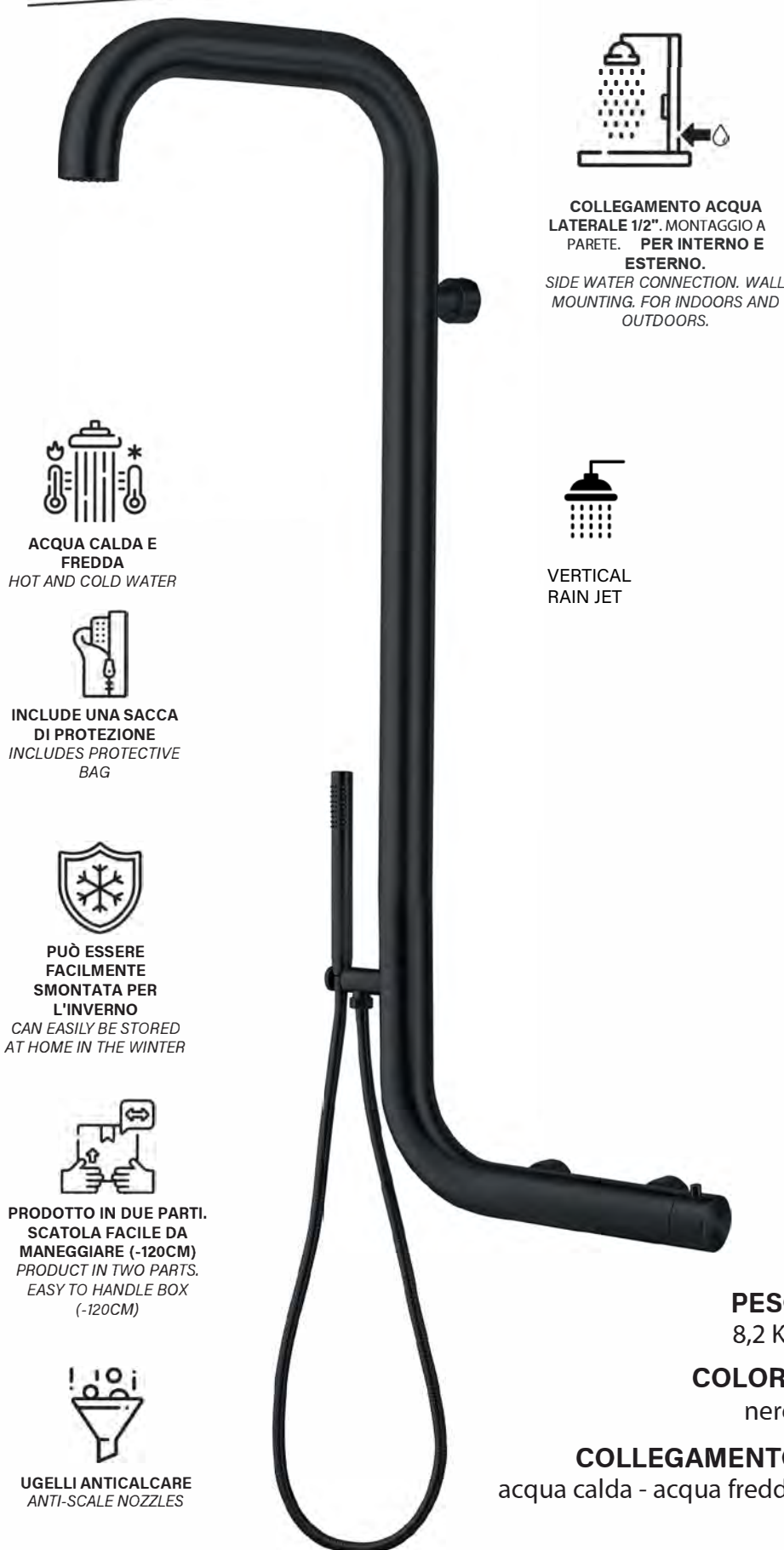

COLLEGAMENTO ACQUA
LATERALE 1/2". MONTAGGIO A
PARETE. PER INTERNO E
ESTERNO.

SIDE WATER CONNECTION. WALL
MOUNTING. FOR INDOORS AND
OUTDOORS.



ACQUA CALDA E
FREDDA
HOT AND COLD WATER



INCLUDE UNA SACCA
DI PROTEZIONE
INCLUDES PROTECTIVE
BAG



PUÒ ESSERE
FACILMENTE
SMONTATA PER
L'INVERNO
CAN EASILY BE STORED
AT HOME IN THE WINTER



PRODOTTO IN DUE PARTI.
SCATOLA FACILE DA
MANEGGIARE (-120CM)
PRODUCT IN TWO PARTS.
EASY TO HANDLE BOX
(-120CM)



UGELLI ANTICALCARE
ANTI-SCALE NOZZLES



VERTICAL
RAIN JET

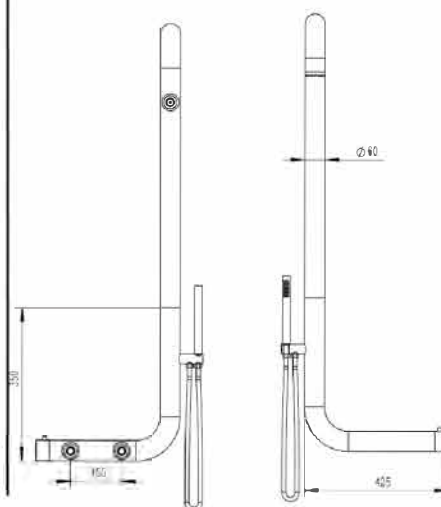
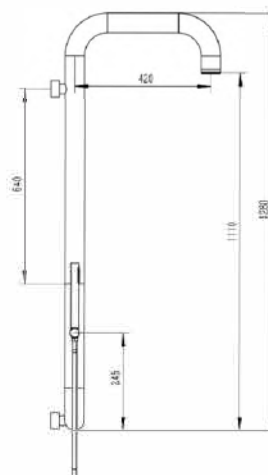

PESO
8,2 KG

COLORE
nero

COLLEGAMENTO
acqua calda - acqua fredda



ORISTANO INOX

La mini doccia per vasca modello Oristano è una doccia in Acciaio Satinato Aisi Inox 316L, detto comunemente acciaio marino. Ottima come bordo vasca o bordo piscina e per diverse applicazioni e ambientazioni anche interne alle abitazioni come il bagno di casa.

La sua particolare realizzazione la rende molto resistente agli agenti atmosferici, salsedine e raggi UV. Diametro del fusto 60 mm, peso 8.5 kg.

Peculiarità

- Doppio ingresso acqua calda e fredda
- Miscelatore a 3 vie per Soffione, permette di avere acqua calda dal soffione e dalla doccetta a mano.
- Attacchi acqua a scomparsa sulla base.
- Rubinetteria in Acciaio Aisi 316L.
- Collegamento acqua dal basso con attacchi rapidi.
- Flessibile del doccino in acciaio inox AISI 304

DEUTSCH

Die kleine Standdusche Oristano ist eine Dusche aus satiniertem Edelstahl Aisi Inox 316L, auch bekannt als Marine-Stahl. Diese Mini-Dusche ist zur Montage ausserhalb einer Badewanne oder am Rand eines Schwimmbeckens geeignet. Schaftdurchmesser 60 mm, Gewicht 8,5 kg.

- Doppelter Warm- und Kaltwasserzulauf
- 3-Wege-Mischbatterie liefert warmes Wasser aus der Kopfbrause und der Handbrause
- Verdeckte Wasseranschlüsse am Sockel
- Armaturen aus rostfreiem Stahl Aisi 316L
- Wasseranschluss von unten mit Schnellkupplungen.
- Handbrauseschlauch aus rostfreiem Stahl AISI 304

FRANÇAIS

La mini-baignoire-douche Oristano est une douche en acier inoxydable satiné Aisi Inox 316L, communément appelé acier marin. Il est idéal pour être utilisé comme bord de baignoire ou de piscine et pour diverses applications et contextes. Diamètre du tambour 60 mm, poids 8,5 kg.

- Double entrée d'eau chaude et froide
- Mélangeur 3 voies pour la tête de douche, permet d'obtenir de l'eau chaude à partir de la tête de douche et de la douche à main.
- Raccordements d'eau dissimulés sur la base.
- Robinetterie en acier inoxydable Aisi 316L.
- Raccordement de l'eau par le bas avec des raccords rapides.
- Flexible de douche à main en acier inoxydable AISI 304.

ENGLISH

The mini bathtub shower model Oristano is a shower in Satin Stainless Steel Aisi Inox 316L, commonly known as marine steel. It is ideal for use as a bath or swimming pool edge and for various applications and settings, including inside homes such as the bathroom. Drum diameter 60 mm, weight 8.5 kg.

- Double hot and cold water inlet
- 3-way mixer for shower head, allows for hot water from the shower head and hand shower.
- Concealed water connections on the base.
- Stainless steel Aisi 316L tapware.
- Water connection from below with quick couplings.
- AISI 304 stainless steel hand shower hose.

ESPAÑOL

La miniducha de bañera modelo Oristano es una ducha de acero inoxidable satinado Aisi Inox 316L, comúnmente conocido como acero marino. Es ideal para utilizarlo como borde de la bañera o de la piscina y para diversas aplicaciones y entornos. Diámetro del tambor 60 mm, peso 8,5 kg.

- Doble entrada de agua caliente y fría
- Mezclador de 3 vías para la alcachofa de la ducha, permite obtener agua caliente de la alcachofa y de la teleducha.
- Conexiones de agua ocultas en la base.
- Grifería de acero inoxidable Aisi 316L.
- Conexión de agua desde abajo con acoplamientos rápidos.
- Manguera de ducha manual de acero inoxidable AISI 304.

DOCCIA-ORISTANO-INOX

8025431018617

ACCIAIO
INOX 316L
NAUTICO NAUTICAL

SISTEMA
INSTALLAZIONE C-BOX
INCLUSO INCLUDED

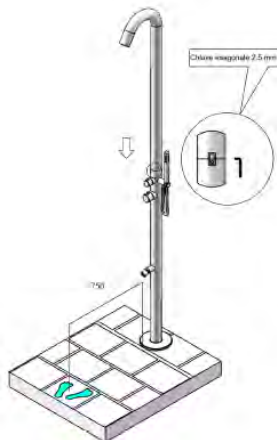
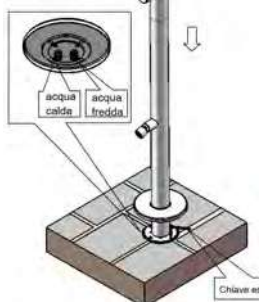
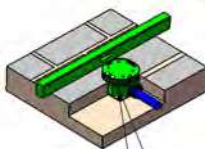
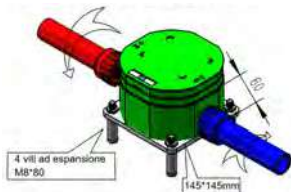

COLLEGAMENTO ACQUA NELLA
PARTE INFERIORE.
ACQUA CALDA E FREDDA.
WATER CONNECTION AT THE
BOTTOM.
HOT AND COLD WATER.



ACQUA CALDA E
FREDDA
HOT AND COLD WATER



INCLUDE UNA SACCA
DI PROTEZIONE
INCLUDES PROTECTIVE
BAG



PUÒ ESSERE
FACILMENTE
SMONTATA PER
L'INVERNO
CAN EASILY BE STORED
AT HOME IN THE WINTER



PRODOTTO IN DUE PARTI.
SCATOLA FACILE DA
MANEGGIARE (-120CM)
PRODUCT IN TWO PARTS.
EASY TO HANDLE BOX
(-120CM)



UGELLI ANTICALCARE
ANTI-SCALE NOZZLES

PESO

8,5 kg

COLORE

Inox satinato

COLLEGAMENTO

acqua calda - acqua fredda

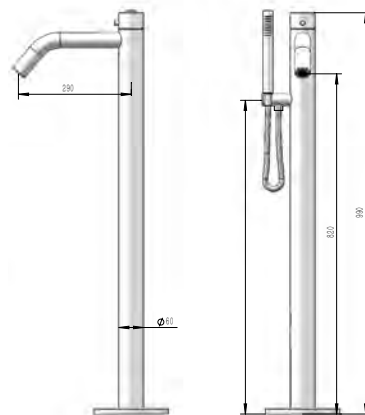
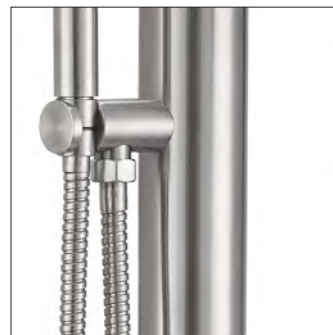
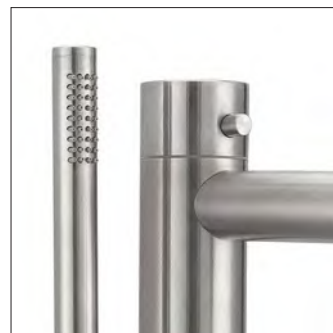



ORISTANO NERA

Rubinetto nero in acciaio inox, praticamente è una mini doccia per vasca da bagno. Realizzato in acciaio satinato Aisi Inox 316L, detto comunemente acciaio marino. Ottimo come bordo vasca o bordo piscina e per diverse applicazioni e ambientazioni anche interne alle abitazioni come il bagno di casa. La sua particolare realizzazione la rende molto resistente agli agenti atmosferici, salsedine e raggi UV. Diametro del fusto 60 mm, peso 8.5 kg.

ESPAÑOL

Grifo de acero inoxidable negro, prácticamente una miniducha de bañera. Fabricado en acero inoxidable satinado Aisi Inox 316L, comúnmente conocido como acero marino. Excelente como borde de bañera o piscina y para diversas aplicaciones y entornos, incluso en el interior de viviendas, como el cuarto de baño de casa. Su especial construcción la hace muy resistente a los agentes atmosféricos, la salinidad y los rayos UV. Diámetro del tambor 60 mm, peso 8,5 kg.

ENGLISH

Black stainless steel tap, practically a mini bathtub shower. Made of satin stainless steel Aisi Inox 316L, commonly known as marine steel. Excellent as a bath or pool edge and for various applications and settings even inside homes such as the bathroom at home. Its special construction makes it highly resistant to atmospheric agents, saltiness and UV rays. Drum diameter 60 mm, weight 8.5 kg.

FRANÇAIS

Robinet en acier inoxydable noir, pratiquement une mini-baignoire-douche. Réalisé en acier inoxydable satiné Aisi Inox 316L, communément appelé acier marin. Excellent comme bord de baignoire ou de piscine et pour diverses applications et réglages, même à l'intérieur des maisons, comme la salle de bains de la maison. Sa construction spéciale le rend très résistant aux agents atmosphériques, à la salinité et aux rayons UV. Diamètre du tambour 60 mm, poids 8,5 kg.

DEUTSCH

Schwarze Edelstahlarmatur, praktisch eine Mini-Badewannendusche. Hergestellt aus satiniertem Edelstahl Aisi Inox 316L, allgemein bekannt als Marinestahl. Hervorragend geeignet als Badewannen- oder Poolrand und für verschiedene Anwendungen und Umgebungen, auch innerhalb von Häusern, wie z. B. das Badezimmer zu Hause. Durch seine spezielle Konstruktion ist es sehr widerstandsfähig gegen Witterungseinflüsse, Salz und UV-Strahlen. Trommeldurchmesser 60 mm, Gewicht 8,5 kg.

DOCCIA-ORISTANO-NERA

8025431150942

SISTEMA
INSTALLAZIONE C-BOX
INCLUSO INCLUDED

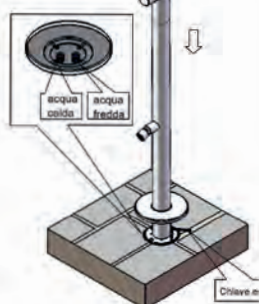
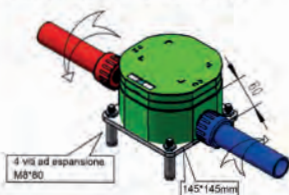

COLLEGAMENTO ACQUA NELLA
PARTE INFERIORE.
ACQUA CALDA E FREDDA.
WATER CONNECTION AT THE
BOTTOM.
HOT AND COLD WATER.



ACQUA CALDA E
FREDDA
HOT AND COLD WATER



INCLUDE UNA SACCA
DI PROTEZIONE
INCLUDES PROTECTIVE
BAG



PUÒ ESSERE
FACILMENTE
SMONTATA PER
L'INVERNO
CAN EASILY BE STORED
AT HOME IN THE WINTER



PRODOTTO IN DUE PARTI.
SCATOLA FACILE DA
MANEGGIARE (-120CM)
PRODUCT IN TWO PARTS.
EASY TO HANDLE BOX
(-120CM)



UGELLI ANTICALCARE
ANTI-SCALE NOZZLES

PESO

8,5 KG

COLORE

nero

COLLEGAMENTO

acqua calda - acqua fredda

ACCIAIO
INOX 316L
NAUTICO NAUTICAL

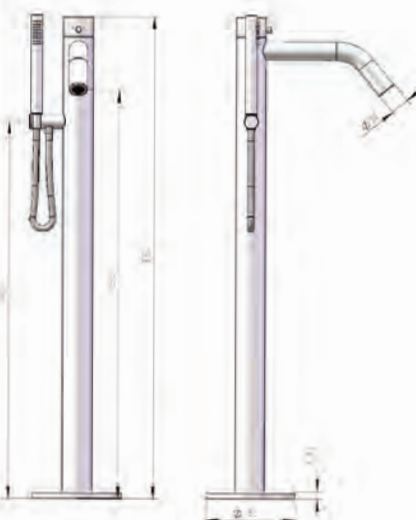

DOCCE SINED IN ALLUMINIO

*Docce Solari in Alluminio con Speciale Ciclo di Verniciatura.
Completo proprio del settore automotive.*

*Dove per completo si intende: pulizia approfondita
alluminio, applicazione fondo/primer, doppio strato
verniciatura, finitura trasparente e verifica finale di
ogni singolo pezzo.*

*Elegantissime e rifinite con profili in alluminio di colore
contrastante. Capacità da 25 a 40 litri.*



Aluminium solar shower with special complete painting cycle specific to the automotive sector.

Where complete means: thorough aluminium cleaning, primer/primer application, double coat of paint, transparent finish. final inspection of each individual part.

*Elegant and finished with aluminium profiles in a contrasting colour
Capacities from 25 to 40 litres.*

Ducha solar de aluminio con ciclo completo de pintura especial específica para el sector del automóvil.

Donde completo significa: limpieza a fondo del aluminio, aplicación de imprimación, doble capa de pintura, acabado transparente. inspección final de cada pieza individual.

Elegante y acabado con perfiles de aluminio en color de contraste

Capacidades de 25 a 40 litros.

Douche solaire en aluminium avec cycle complet de peinture spécifique au secteur automobile.

Par complet, on entend : nettoyage approfondi de l'aluminium, application d'une couche d'apprêt/de fond, double couche de peinture, finition transparente. contrôle final de chaque pièce individuelle.

Élégant et fini avec des profilés en aluminium d'une couleur contrastante.

Capacités de 25 à 40 litres.

Aluminium-Solardusche mit speziellem, vollständigem Lackierzyklus speziell für den Automobilsektor.

Vollständig bedeutet: gründliche Reinigung des Aluminiums, Auftragen der Grundierung, doppelte Lackierung, transparentes Finish, Endkontrolle jedes einzelnen Teils.

*Elegant und mit Aluminiumprofilen in Kontrastfarbe ausgeführt
Fassungsvermögen von 25 bis 40 Litern.*



DINO

Doccia da esterno DINO colore nero. Struttura in Alluminio- riscaldamento Solare - 26 litri. Soffione di grandi dimensioni con ugelli in silicone anticalcare. Lavapiedi e accessori in ottone colore Black Matt. Tappo per svuotamento doccia. Attacco acqua per riempimento in ingresso. Filtro Anticalcare. Tasselli con speciali boccole in Nylon per protezione fissaggio. Sacca protettiva inclusa.

DEUTSCH

Solar-Außendusche Dino aus Aluminium Farbe Schwarz - Solarheizung - 26 Liter Tank

Großer Duschkopf mit Anti-Kalk-Silikondüsen, Wassertank 26 Liter Fassungsvermögen, Solarheizung.

Fußwaschhahn und Zubehör aus Messing Farbe Schwarz Matt, Ablaufstopfen zum Entleeren der Dusche, Einfüllstutzen, Anti-Kalk-Filter

Dübel mit speziellen Nylonbuchsen zum Schutz der Dusche bei Aufbau und Gebrauch, Schutzhülle inbegriffen

FRANÇAIS

Douche extérieure DINO en couleur NOIR .Structure en aluminium .Chauffage solaire

Grand pommeau de douche avec buses en silicone anticalcaire

Capacité de 26 litres d'eau chauffée par le soleil. Rince-pieds et accessoires en laiton couleur noire matt.

Bouchon de vidage pour la douche. Fixation en entrée pour remplissage de l'eau. Filtre anticalcaire

Bouchons avec bagues en nylon spéciales pour la protection pendant le montage et l'utilise

Sac de protection

ENGLISH

Aluminium outdoor solar shower DINO, color BLACK, structure heated by the sun rays.

Large shower head with anti-limescale silicone nozzles

26 liters capacity of solar heated water

Footwasher and accessories in brass color Black Matt

Draining plug for shower. Inlet filler tap. Anti-scale filter

Plugs with special nylon bushings for fixing protection

Protection bag included

ESPAÑOL

Ducha exterior Estructura de aluminio con calefacción solar .

Ducha grande con boquillas de silicona anticalcárea

Capacidad de 26 litros de agua calentada por energía solar

Lavapiés y accesorios de latón color Negro Mate

Tapón de desagüe para la ducha. Grifo de llenado de entrada. 1 Filtro anticalcáreo

Tapones con casquillos especiales de nylon para la protección de la fijación

Bolsa de protección

DOCCIA-DINO

8025431017245



COLLEGAMENTO ACQUA LATERALE
1/2" SIDE WATER CONNECTION

ACCESSORI IN OTTONE BLACK MATT.
ACCESSORIES MADE OF BRASS



DOCCIA RISCALDAMENTO SOLARE
SOLAR HEATING SHOWER

INCLUDE UNA SACCA DI PROTEZIONE
INCLUDES PROTECTIVE BAG



FILTRO ANTICALCARE ESTERNO
INCLUSO EXTERNAL ANTI-SCALE FILTER INCLUDED

CAPACITÀ DEL SERBATOIO 26 L
TANK CAPACITY 26 L



UGELLI ANTICALCARE
ANTI-SCALE NOZZLES

TUBI INTERNI IN ACCIAIO FINO A 15 KG DI PRESSIONE
BRAIDED STEEL INNER HOSE UP TO 15 KG PRESSURE



TAPPO DI DRENAGGIO
DRAINING PLUG

TASSELLI, VITI E BOCCOLE IN NYLON RINFORZATO PER UN MIGLIORE FISSAGGIO AL SUOLO
DOWELS, SCREWS AND BUSHES MADE OF REINFORCED NYLON FOR BETTER FASTENING TO THE GROUND



IL DOPPIO DELLO SPES-SORE. PIÙ RESISTENTE.
TWICE AS THICK. MORE RESISTANT.

COLLEGAMENTO ALL'ACQUA IN UN SOLO TUBO
CONNECTION TO WATER IN ONLY 1 PIPE



VALVOLA DI INTERCETTAZIONE DELL'ACQUA
WATER SHUT-OFF VALVE



ALLUMINIO
ALUMINIUM

PESO

15 Kgs

COLORE

Nero RAL 9004

LITRI

26

*Un Collegamento acqua 1/2" laterale
Elegante*



PROLUNGA DEL SOFFIONE PERMETTE DI ORIENTARLO MEGLIO
SHOWER HEAD EXTENSION ALLOWS FOR BETTER ORIENTATION

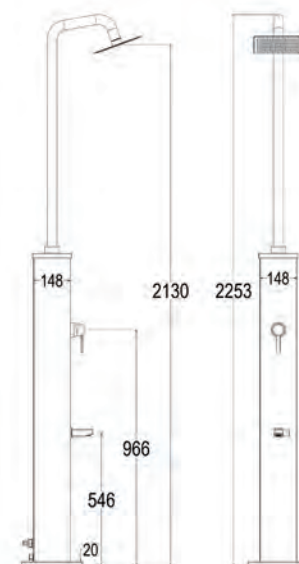
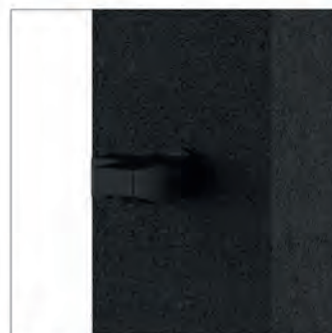
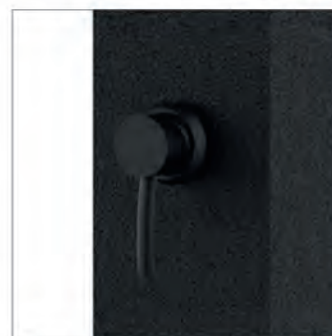



DAFNE BLU

Doccia da esterno DAFNE colore BLU, in Alluminio riscaldamento Solare. Soffione di grandi dimensioni con ugelli in silicone anticalcare. Capacità 35 litri (riscaldamento Solare).

Lavapiedi e accessori in ottone colore Black Matt. Tappo per svuotamento doccia. Filtro Anticalcare. Tasselli con speciali boccole in Nylon per protezione fissaggio Sacca protettiva inclusa.

DEUTSCH

Solar-Außendusche Dafne aus Aluminium Farbe Blau.

Großer Duschkopf mit Anti-Kalk-Silikondüsen, Wassertank 35 Liter Fassungsvermögen, Solarheizung.

Fußwaschhahn und Zubehör aus Messing Farbe Schwarz Matt, Ablaufstopfen zum Entleeren der Dusche,

Anti-Kalk-Filter, Dübel mit speziellen Nylonbuchsen zum Schutz der Dusche bei Aufbau und Gebrauch, Schutzhülle inbegriffen.

FRANÇAIS

Douche extérieure DAFNE en aluminium, couleur BLEU, chauffage solaire.

Grande pommeau de douche avec buses en silicone anticalcaires Capacité 35 litres - chauffage solaire-.

Rince-pieds et accessoires en laiton noir matt Bouchon de vidage de douche

Filtre anticalcaires Bouchons avec douilles spéciales en nylon pour la protection et la fixation Sac de protection inclus.

ENGLISH

Outdoor shower DAFNE color BLUE, in Aluminum solar heating.

Large shower head with anti-scale silicone nozzles. Capacity: 35 liters of water heated by the sun.

Foot washer and accessories in brass, Black matt color. Cap for draining the shower.

Anti-scale filter. Dowels with special bushings in nylon to protect during fixing action .Protective bag included.

ESPAÑOL

Ducha exterior DAFNE Blue. Con Calefacción solar. De aluminio.

Gran cabezal de ducha con boquillas de silicona anticalcárea Capacidad de 35 litros de agua de calefacción solar.

Lavapiés y accesorios en color latón Negro Mate. Tapón de desagüe de la ducha.

Filtro anticalcáreo. Tapones con casquillos especiales de nylon para su protección y fijación. Bolsa de protección.

DOCCIA-DAFNE

DOCCIA-DAFNE-BLU

8025431017269



DOCCIA-DAFNE-BIANCA
8025431017252



DOCCIA-DAFNE-NERA
8025431017276

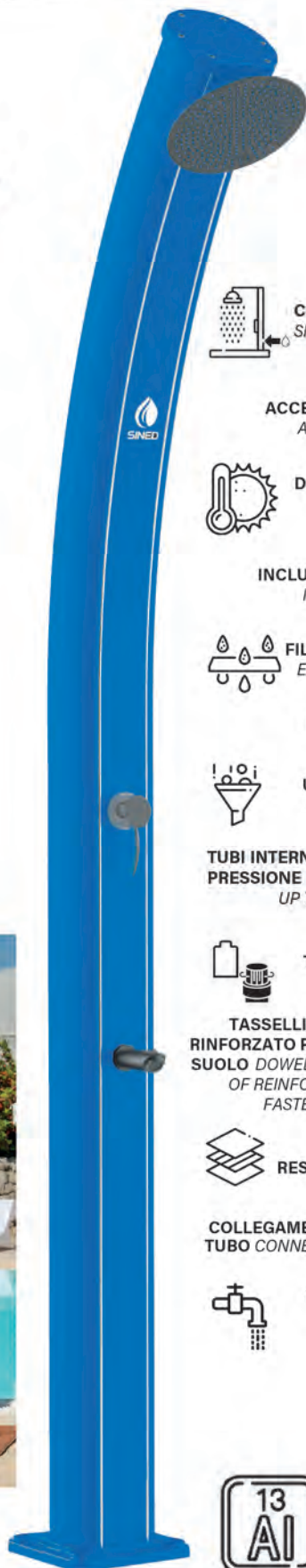
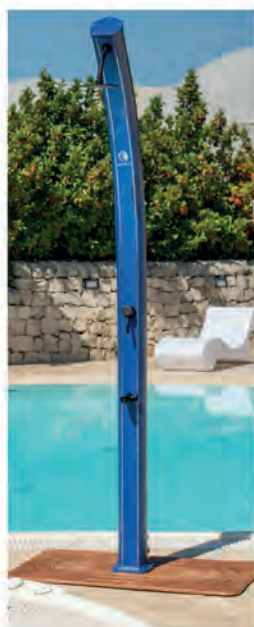

Un Collegamento acqua
1/2" laterale
Limited Edition



COLLEGAMENTO ACQUA LATERALE 1/2"
SIDE WATER CONNECTION

ACCESSORI IN OTTONE BLACK MATT.
ACCESSORIES MADE OF BRASS



DOCCIA RISCALDAMENTO SOLARE
SOLAR HEATING SHOWER

INCLUDE UNA SACCA DI PROTEZIONE
INCLUDES PROTECTIVE BAG



FILTRO ANTICALCARE ESTERNO INCLUSO
EXTERNAL ANTI-SCALE FILTER INCLUDED

CAPACITÀ DEL SERBATOIO 36 L
TANK CAPACITY 36 L



UGELLI ANTICALCARE
ANTI-SCALE NOZZLES

TUBI INTERNI IN ACCIAIO FINO A 15 KG DI
PRESSIONE BRAIDED STEEL INNER HOSE
UP TO 15 KG PRESSURE



TAPPO DI DRENAGGIO
DRAINING PLUG

TASSELLI, VITI E BOCCOLE IN NYLON
RINFORZATO PER UN MIGLIORE FISSAGGIO AL
SUOLO DOWELS, SCREWS AND BUSHES MADE
OF REINFORCED NYLON FOR BETTER
FASTENING TO THE GROUND



IL DOPIO DELLO SPES-SORE. PIÙ
RESISTENTE. TWICE AS THICK. MORE RESISTANT.

COLLEGAMENTO ALL'ACQUA IN UN SOLO
TUBO CONNECTION TO WATER IN ONLY 1 PIPE



VALVOLA DI INTERCETTAZIONE
DELL'ACQUA
WATER SHUT-OFF VALVE

LITRI

35

PESO

12,5 kg

COLORE

Blu RAL 5002
Bianco RAL 9003
Nero RAL 9004



PROLUNGA DEL
SOFFIONE PERMETTE DI
ORIENTARLO MEGLIO
SHOWER HEAD
EXTENSION ALLOWS FOR
BETTER ORIENTATION

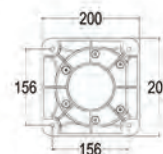
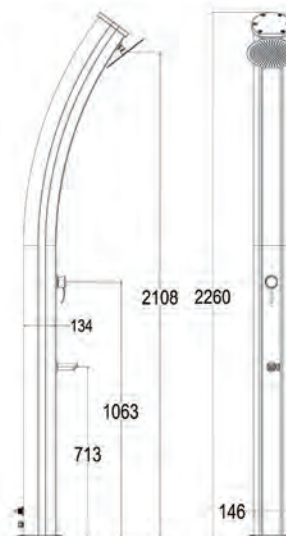
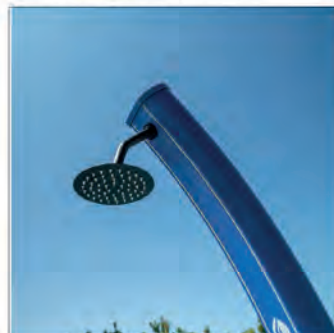



ELLA GRIGIO WOOD (EFFETTO LEGNO)

Doccia da esterno ELLA. In Alluminio colore GRIGIO con inserto colore legno riscaldamento Solare.

Capacità 40 litri. Soffione quadrato di grandi dimensioni con ugelli anticalcare. avapiedi e accessori in ottone Black Matt. Tappo per svuotamento doccia. Filtro Anticalcare.

Tasselli con speciali boccole in Nylon per protezione fissaggio. Sacca Protettiva per fine stagione inclusa.

DEUTSCH

ELLA Außensolardusche aus Aluminium. Farbe GRAU mit holzfarbenem Einsatz, Solarheizung.

Fassungsvermögen von 40 Litern.

Großer quadratischer Duschkopf mit Anti-Kalk-Düsen Fußwaschanlage und Zubehör in Messing Schwarz Matt.

Abflusstopfen für die Dusche Anti-Kalk-Filter Stopfen mit speziellen Nylonbuchsen zum Schutz der Befestigung Schutztasche für das Saisonende, im Lieferumfang enthalten

FRANÇAIS

Douche solaire extérieure ELLA en aluminium. Couleur GRISE avec insert en bois, chauffage solaire. Capacité de 40 litres.

Large pommeau de douche carré avec buses anti-calcaire Rondelle de pied et accessoires en laiton noir mat

Bouchon de vidange pour la douche Filtre anti-calcaire Bouchons avec douilles spéciales en nylon pour la protection de la fixation Sac de protection pour la fin de saison, inclus

ENGLISH

ELLA outdoor solar shower in Aluminium. Color GREY with wood-colored insert, solar heating. Capacity of 40 liters.

Large square shower head with anti-limescale nozzles Foot washer and accessories in Black Matt brass

Drain plug for shower Anti-limescale filter Plugs with special nylon bushes for fixing protection Protective bag for season end, included

ESPAÑOL

Ducha exterior Ella gris con inserto de aluminio color madera calefacción solar 40 litros.

Ducha cuadrada grande con boquillas anticalcáreas Lavapiés y accesorios en latón negro mate.

Tapón de desagüe para la ducha 1 filtro anticalcáreo Tapones con casquillos especiales de nylon para la protección de la fijación Bolsa de protección para el final de la temporada.

DOCCIA-ELLA

DOCCIA-ELLA-GRIGIA-WOOD

8025431016910

Un Collegamento acqua 1/2" laterale
Bellissima



- 
COLLEGAMENTO ACQUA LATERALE
1/2" SIDE WATER CONNECTION
- 
ACCESSORI IN OTTONE BLACK MATT. ACCESSORIES MADE OF BRASS
- 
DOCCIA RISCALDAMENTO SOLARE
SOLAR HEATING SHOWER
- 
INCLUDE UNA SACCA DI PROTEZIONE
INCLUDES PROTECTIVE BAG
- 
FILTRO ANTICALCARE ESTERNO
INCLUSO EXTERNAL ANTI-SCALE FILTER INCLUDED
- 
CAPACITÀ DEL SERBATOIO 40 L
TANK CAPACITY 40 L
- 
UGELLI ANTICALCARE
ANTI-SCALE NOZZLES
- 
TUBI INTERNI IN ACCIAIO FINO A 15 KG DI PRESSIONE
BRAIDED STEEL INNER HOSE UP TO 15 KG PRESSURE
- 
TAPPO DI DRENAGGIO
DRAINING PLUG
- 
TASSELLI, VITI E BOCCOLE IN NYLON RINFORZATO PER UN MIGLIORE FISSAGGIO AL SUOLO
DOWELS, SCREWS AND BUSHES MADE OF REINFORCED NYLON FOR BETTER FASTENING TO THE GROUND
- 
IL DOPIO DELLO SPES-SORE. PIÙ RESISTENTE.
TWICE AS THICK. MORE RESISTANT.
- 
COLLEGAMENTO ALL'AC-QUA IN UN SOLO TUBO
CONNECTION TO WATER IN ONLY 1 PIPE
- 
VALVOLA DI INTERCETTA-ZIONE DELL'ACQUA
WATER SHUT-OFF VALVE

13
AI ALLUMINIO
ALUMINIUM

PESO
17,5 kg

COLORE

Grigio RAL 7048 + WOOD 001
Nera RAL 9004 + NN7851-4

LITRI
40

DOCCIA-ELLA-NERA-INOX
8025431016927



PROLUNGA DEL SOFFIONE PERMETTE DI ORIENTARLO MEGLIO
SHOWER HEAD EXTENSION ALLOWS FOR BETTER ORIENTATION

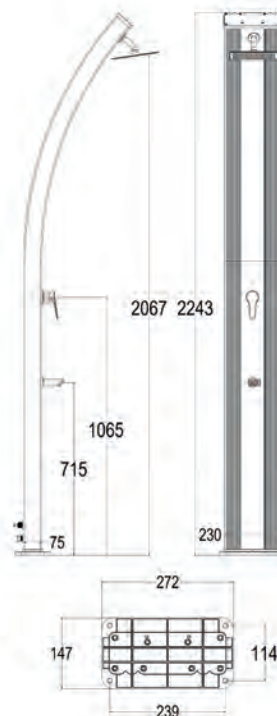



LEA GRIGIA

Doccia da esterno a riscaldamento Solare LEA in Alluminio. Colore GRIGIO Capacita': 30 litri. Soffione quadrato di grandi dimensioni con ugelli anticalcare.

Lavapiedi e accessori in ottone colore Black Matt. Tappo per svuotamento doccia. Filtro Anticalcare.

Tasselli con speciali boccole in Nylon per protezione fissaggio. Sacca Protettiva per fine stagione, inclusa.

DEUTSCH

Solar-Außendusche Lea aus Aluminium Farbe Grau - Solarheizung - 30 Liter Wassertank.

Großer quadratischer Duschkopf mit Anti-Kalk-Düsen.

Fußwaschhahn und Zubehör aus Messing Farbe Schwarz Matt, Ablaufstopfen zum Entleeren der Dusche, Anti-Kalk-Filter.

Dübel mit speziellen Nylonbuchsen zum Schutz der Dusche bei Aufbau und Gebrauch, Schutzhülle inbegriffen

FRANÇAIS

LEA Douche solaire pour l'extérieure en aluminium. Couleur GRIS. Capacité : 30 litres.

Grande pommeau de douche carrée avec buses anticalcaire Rince-pieds et accessoires en laiton black matt.

Bouchon de vidage pour la douche. Filtre anticalcaire.

Bouchons avec douilles en nylon spécial pour la protection pendant le montage Sac de protection pour la fin de la saison, inclus.

ENGLISH

LEA Solar heated outdoor shower in aluminium. GREY color. 30 liters capacity.

Large square shower head with anti-limescale nozzles Black matt brass foot washer and accessories.

Draining plug for shower. Anti-limescale filter .

Plugs with special nylon bushes for fixing protection Protective bag for end of season.

ESPAÑOL

LEA Ducha exterior de aluminio con calefacción solar 30 litros.

Ducha cuadrada grande con boquillas anticalcáreas Lavapiés de latón cromado y accesorios.

Tapón de desagüe para la ducha 1 filtro anticalcáreo.

Tapones con casquillos de nylon especiales para la protección de la fijación Bolsa de protección para el final de la temporada.

DOCCIA-LEA

DOCCIA-LEA-GRIGIA

8025431016989

Un Collegamento acqua 1/2"
laterale
Speciale



COLLEGAMENTO ACQUA LATERALE
1/2" SIDE WATER CONNECTION

ACCESSORI IN OTTONE BLACK
MATT. ACCESSORIES MADE OF BRASS



DOCCIA RISCALDAMENTO SOLARE
SOLAR HEATING SHOWER

INCLUDE UNA SACCA DI PROTEZIONE
INCLUDES PROTECTIVE BAG



FILTRO ANTICALCARE ESTERNO
INCLUSO EXTERNAL ANTI-SCALE FILTER
INCLUDED

CAPACITÀ DEL SERBATOIO 30 L
TANK CAPACITY 30 L



UGELLI ANTICALCARE
ANTI-SCALE NOZZLES



TUBI INTERNI IN ACCIAIO FINO A 15 KG DI
PRESSIONE BRAIDED STEEL INNER HOSE
UP TO 15 KG PRESSURE



TAPPO DI DRENAGGIO
DRAINING PLUG

TASSELLI, VITI E BOCCOLE IN NYLON
RINFORZATO PER UN MIGLIORE FISSAGGIO AL
SUOLO DOWELS, SCREWS AND BUSHES MADE
OF REINFORCED NYLON FOR BETTER
FASTENING TO THE GROUND



IL DOPIO DELLO SPES-SORE. PIÙ RESISTENTE.
TWICE AS THICK. MORE RESISTANT.

COLLEGAMENTO ALL'AC-QUA IN UN SOLO TUBO
CONNECTION TO WATER IN ONLY 1 PIPE



VALVOLA DI INTERCETTA-ZIONE
DELL'ACQUA
WATER SHUT-OFF VALVE



ALLUMINIO
ALUMINIUM

PESO
15 kg

COLORE
Grigio RAL 9023
Nera RAL 9004

LITRI
30

DOCCIA-LEA-NERA
8025431017351



PROLUNGA DEL
SOFFIONE PERMETTE DI
ORIENTARLO MEGLIO
SHOWER HEAD
EXTENSION ALLOWS FOR
BETTER ORIENTATION

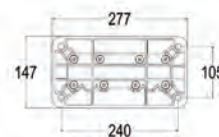

DOCCE SOLE

*Docce polietilene solare solo un collegamento di acqua
Proposte in varie colorazioni. Capacità: Fino a 40 litri (a
seconda del modello)*

*Solar polyethylene showers only one
water connection Available in various
colours. Capacity: Up to 40 litres
(depending on model)*

*Duchas solares de polietileno Una
sola toma de agua Disponible en
varios colores. Capacidad: Hasta 40
litros (según el modelo)*

*Douches solaires en polyéthylène avec
un seul raccordement d'eau
Disponible en plusieurs couleurs.
Capacité: Jusqu'à 40 litres (selon le
modèle)*

*Duschen aus Solar-Polyethylen mit nur
einem Wasseranschluss
Erhältlich in verschiedenen Farben.
Fassungsvermögen: Bis zu 40 Liter (je
nach Modell)*

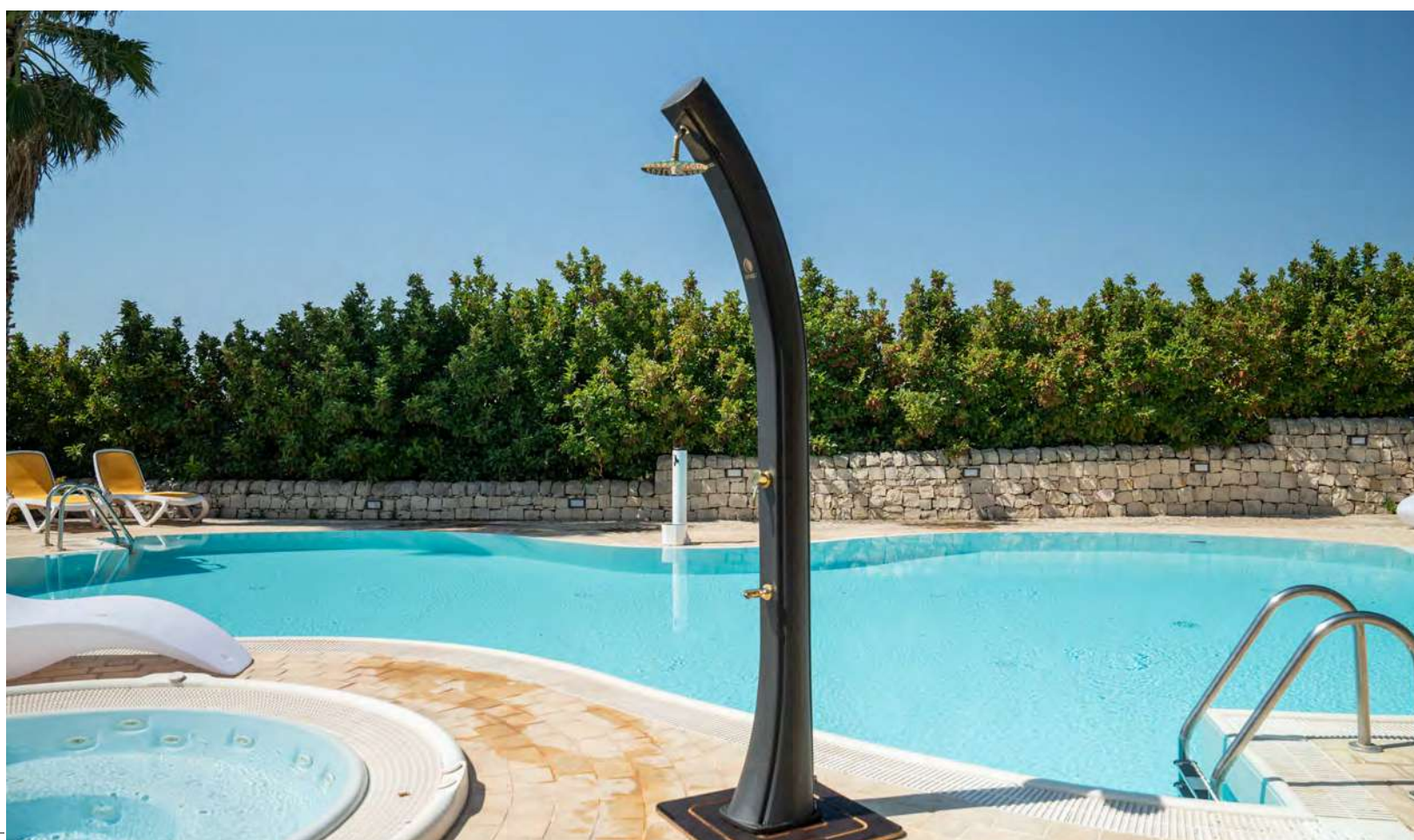

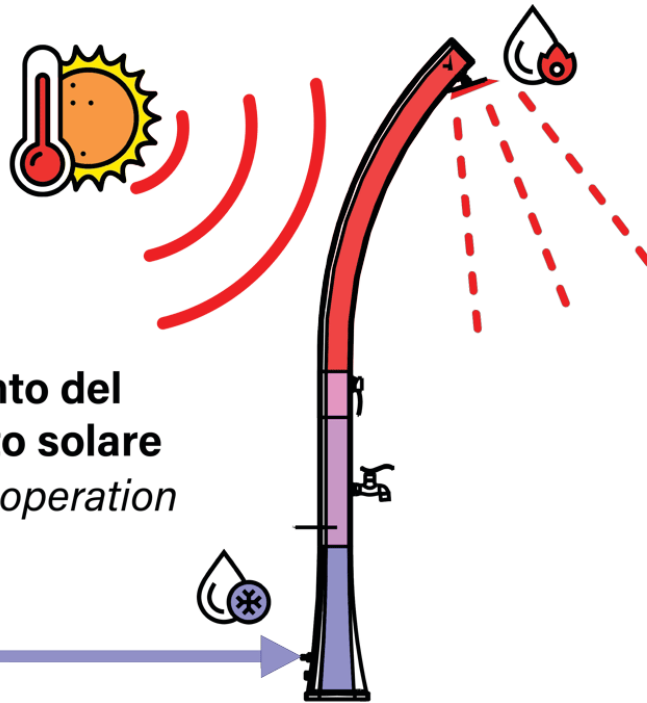

Funzionamento del riscaldamento solare
Solar heating operation

Temperatura massima
Cambia in base al colore

Max. temperature
Changes according to colour

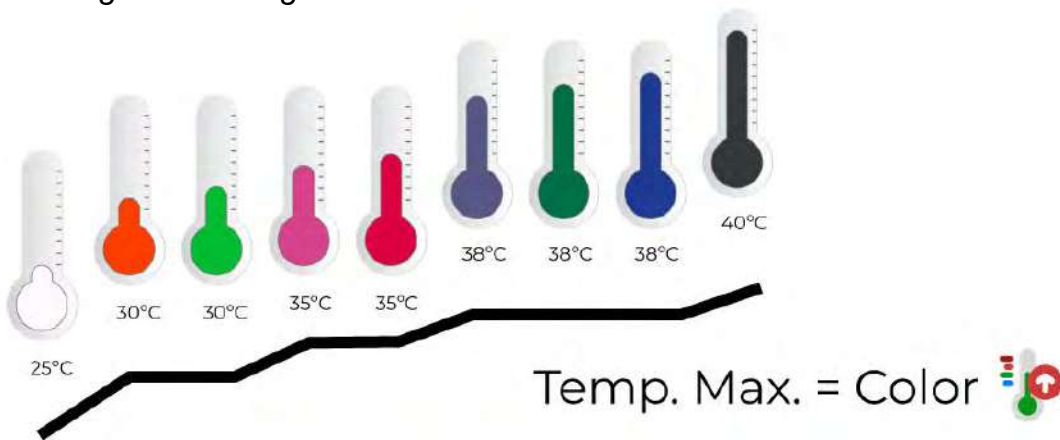



SOLE

Doccia da esterno Sole Bianca in Polietilene. Riscaldamento Solare capacità 22 litri. Soffione di grandi dimensioni con ugelli in silicone anticalcare.

Lavapiedi e accessori in ottone colore Black Matt. Tappo per svuotamento doccia

Rubinetto per riempimento in ingresso. 1 Filtro Anticalcare

Tasselli con speciali boccole in Nylon per protezione fissaggio. Sacca Protettiva per fine stagione

DEUTSCH

Außendusche Sun White aus Polyethylen. Solarbeheiztes Fassungsvermögen von 22 Litern. Großer Duschkopf mit Anti-Kalk-Silikondüsen.

Fußwaschanlage und Zubehör aus Messing in der Farbe Schwarz Matt. Abflussstopfen der Dusche Einfüllstutzen. 1 Anti-Kalk-Filter
Stopfen mit speziellen Nylonbuchsen für den Befestigungsschutz.

Schutztasche für das Ende der Saison

FRANÇAIS

Douche extérieure chauffée par le soleil en polyéthylène, capacité de 22 litres

Grand pommeau de douche avec buses en silicone anticalcaire

Rince-pieds et accessoires en laiton noir mat Bouchon de vidange de douche

Robinet de remplissage d'entrée 1 Filtre anticalcaire

Bouchons avec douilles en nylon spéciales pour la protection pendant le montage et l'utilise. Fixations Sac de protection pour la fin de la saison.

ENGLISH

Polyethylene solar heated outdoor shower 22 liters capacity

Large shower head with anti-limescale silicone nozzles

Foot wash and accessories in brass color Black Matt Shower draining plug.

One in let water connection. One anti-scale filter

Plugs with special nylon bushings for fixing protection Protective bag for end of season

ESPAÑOL

Ducha exterior de polietileno con calefacción solar de 22 litros de capacidad

Ducha grande con boquillas de silicona anticalcárea

Lavapiés y accesorios en color latón Negro Mate Tapón de desagüe de la ducha

Grifo de entrada. 1 Filtro anticalcáreo .

Tapones con casquillos de nylon especiales para la protección de la fijación Bolsa de protección para el final de la temporada

DOCCIA-SOLE-BIANCA

8025431017009



DOCCIA-SOLE-ROSSA
8025431017139

DOCCIA-SOLE-BLU
8025431017122

DOCCIA-SOLE-GRIGIA
8025431017016

DOCCIA-SOLE-NERA
8025431017023

DOCCIA-SOLE-VERDE
8025431017504

POLIETILENE HD
POLYETHYLENE HD

COLLEGAMENTO ACQUA LATERALE
1/2" SIDE WATER CONNECTION

ACCESSORI IN OTTONE BLACK MATT.
ACCESSORIES MADE OF BRASS

DOCCIA RISCALDAMENTO SOLARE
SOLAR HEATING SHOWER

INCLUDE UNA SACCA DI PROTEZIONE
INCLUDES PROTECTIVE BAG

FILTRO ANTICALCARE ESTERNO
INCLUSO EXTERNAL ANTI-SCALE FILTER INCLUDED

CAPACITÀ DEL SERBATOIO 25 L
TANK CAPACITY 25 L

UGELLI ANTICALCARE
ANTI-SCALE NOZZLES

TUBO INTERNO IN TEFLON FINO A 12 KG DI PRESSIONE
TEFLON INNER TUBE UP TO 12 KG OF PRESSURE

TAPPO DI DRENAGGIO
DRAINING PLUG

TASSELLI, VITI E BOCCOLE IN NYLON RINFORZATO PER UN MIGLIORE FISSAGGIO AL SUOLO
DOWELS, SCREWS AND BUSHES MADE OF REINFORCED NYLON FOR BETTER FASTENING TO THE GROUND

IL DOPIO DELLO SPESSORE. PIÙ RESISTENTE.
TWICE AS THICK. MORE RESISTANT.

COLLEGAMENTO ALL'ACQUA IN UN SOLO TUBO
CONNECTION TO WATER IN ONLY 1 PIPE

VALVOLA DI INTERCETTAZIONE DELL'ACQUA
WATER SHUT-OFF VALVE

LITRI 22 **PESO** 8,5 Kg

COLORE

Bianco RAL 9003, Rosso RAL 3018, Grigio RAL 7037, Nera RAL 9017, Blue RAL 5012, Verde



PROLUNGA DEL SOFFIONE PERMETTE DI ORIENTARLO MEGLIO
SHOWER HEAD EXTENSION ALLOWS FOR BETTER ORIENTATION

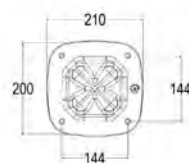
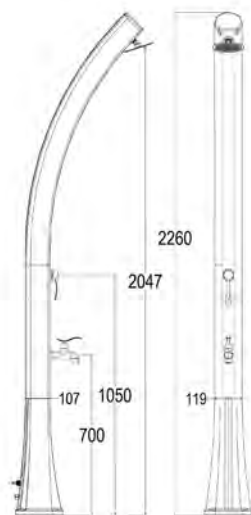

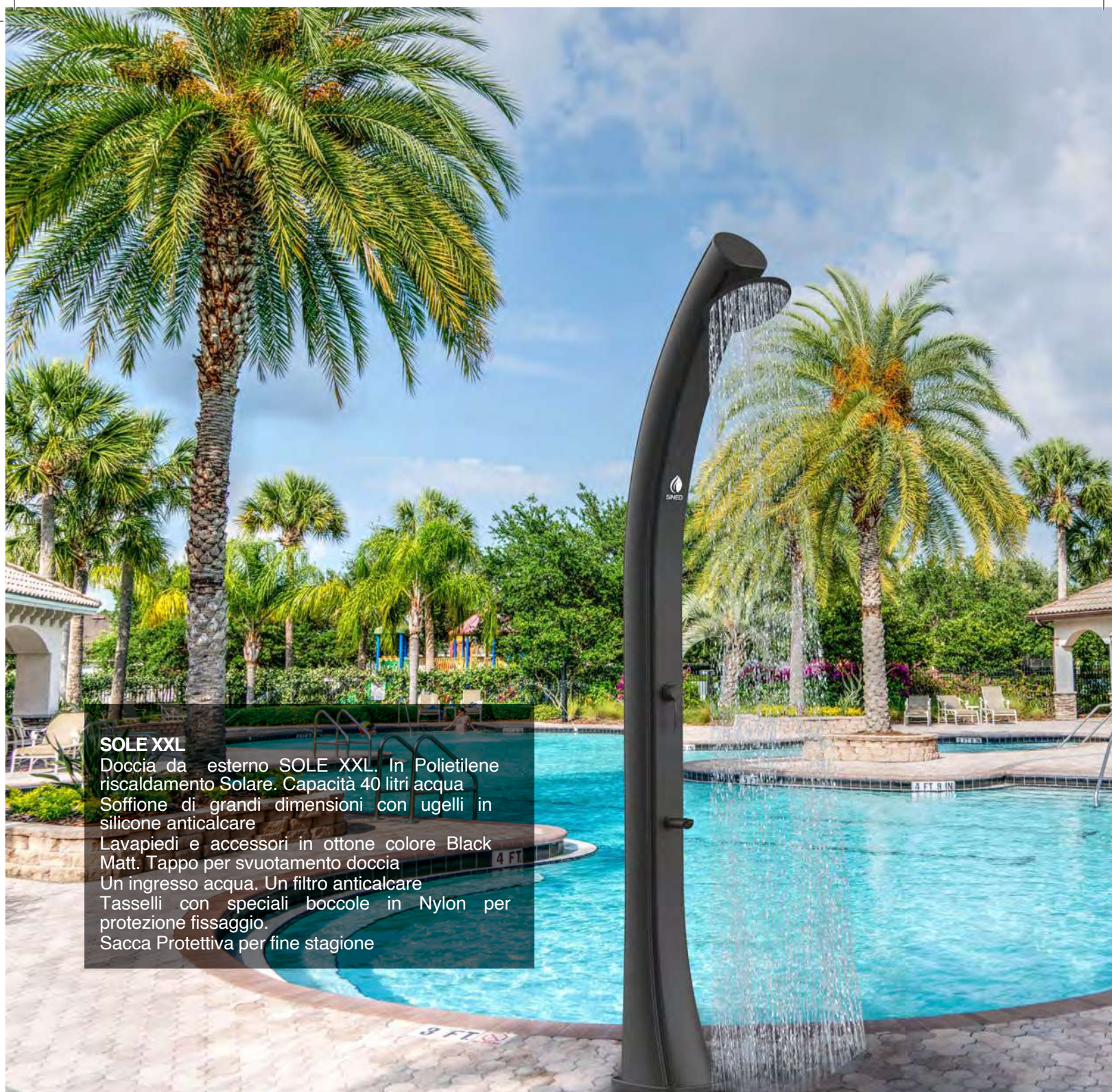

SOLE XXL

Doccia da esterno SOLE XXL. In Polietilene riscaldamento Solare. Capacità 40 litri acqua
 Soffione di grandi dimensioni con ugelli in silicone anticalcare
 Lavapiedi e accessori in ottone colore Black Matt. Tappo per svuotamento doccia
 Un ingresso acqua. Un filtro anticalcare
 Tasselli con speciali boccole in Nylon per protezione fissaggio.
 Sacca Protettiva per fine stagione

DEUTSCH

Solar-Außendusche Sole XXL aus Polyethylen Farbe - Solarheizung - 40 Liter Wassertank.

Großer Duschkopf mit Anti-Kalk-Silikondüsen.

Fußwaschhahn und Zubehör aus Messing Farbe Schwarz Matt, Einfüllhahn und Ablaufstopfen zum Entleeren der Dusche, Anti-Kalk-Filter.

Dübel mit speziellen Nylonbuchsen zum Schutz der Dusche bei Aufbau und Gebrauch, Schutzhülle inbegriffen

FRANÇAIS

Douche extérieure Sole XXL en polyéthylène. Capacité de chauffage solaire 40 litres d'eau.

Grand pommeau de douche avec buses en silicone anticalcaire.

Lave-pieds et accessoires en laiton noir mat Bouchon de vidange de douche.

Robinet de remplissage d'entrée 1 Filtre anticalcaire .

Bouchons avec bagues en nylon spéciales pour la protection pendant le montage et l'utilise.
 Sac de protection pour la fin de la saison

ENGLISH

Outdoor shower Sole XXL in Polyethylene solar heating capacity 40 liters water

Large shower head with anti-limescale silicone nozzles

Foot washer and accessories in Black Matt brass Shower drain plug

Inlet filler tap 1 Anti-scale filter Plugs with special nylon bushings for fixing protection Protective bag for end of season

ESPAÑOL

Ducha exterior SOLE XXL de polietileno capacidad de calentamiento solar 40 litros de agua

Ducha grande con boquillas de silicona anticalcárea

Lavapiés y accesorios en latón negro mate Tapón de desagüe de la ducha

Grifo de entrada 1 Filtro anticalcáreo.

Tapones con casquillos de nylon especiales para la protección de la fijación Bolsa de protección para el final de la temporada

DOCCIA-SOLE-XXL

DOCCIA-SOLE-XXL-BIANCA

8025431017146



DOCCIA-SOLE-XXL-ROSSA
8025431017184



DOCCIA-SOLE-XXL-BLU
8025431017153



DOCCIA-SOLE-XXL-GRIGIA
8025431017160



DOCCIA-SOLE-XXL-NERA
8025431017177



DOCCIA-SOLE-XXL-VERDE
8025431017528



COLLEGAMENTO ACQUA LATERALE
1/2" SIDE WATER CONNECTION

ACCESSORI IN OTTONE BLACK
MATT. ACCESSORIES MADE OF BRASS



DOCCIA RISCALDAMENTO SOLARE
SOLAR HEATING SHOWER

INCLUDE UNA SACCA DI PROTEZIONE
INCLUDES PROTECTIVE BAG



FILTRO ANTICALCARE ESTERNO
INCLUSO EXTERNAL ANTI-SCALE FILTER
INCLUDED

CAPACITÀ DEL SERBATOIO 40 L
TANK CAPACITY 40 L



UGELLI ANTICALCARE
ANTI-SCALE NOZZLES

TUBO INTERNO IN TEFLON FINO A 12 KG DI
PRESSIONE
TEFLON INNER TUBE UP TO 12 KG OF PRESSURE



TAPPO DI DRENAGGIO
DRAINING PLUG

TASSELLI, VITI E BOCCOLE IN NYLON
RINFORZATO PER UN MIGLIORE FISSAGGIO AL
SUOLO DOWELS, SCREWS AND BUSHES MADE
OF REINFORCED NYLON FOR BETTER
FASTENING TO THE GROUND



IL DOPPIO DELLO SPESSORE. PIÙ RESISTENTE.
TWICE AS THICK. MORE RESISTANT.

COLLEGAMENTO ALL'ACQUA IN UN SOLO TUBO
CONNECTION TO WATER IN ONLY 1 PIPE



VALVOLA DI INTERCETTAZIONE
DELL'ACQUA
WATER SHUT-OFF VALVE

LITRI

40

PESO

13,5Kg

COLORE

Bianco RAL 9003, Rosso RAL 3018,
Grigio RAL 7037, Nera RAL 9017, Blue
RAL 5012, Verde



POLIETILENE HD
POLYETHYLENE HD



PROLUNGA DEL
SOFFIONE PERMETTE DI
ORIENTARLO MEGLIO
SHOWER HEAD
EXTENSION ALLOWS FOR
BETTER ORIENTATION

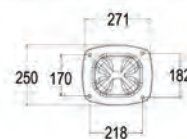
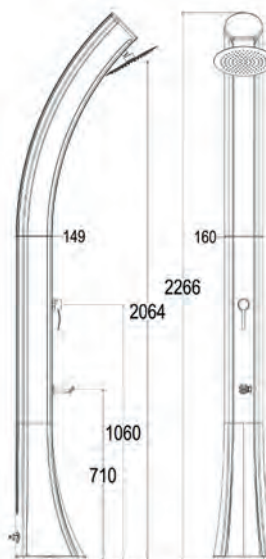

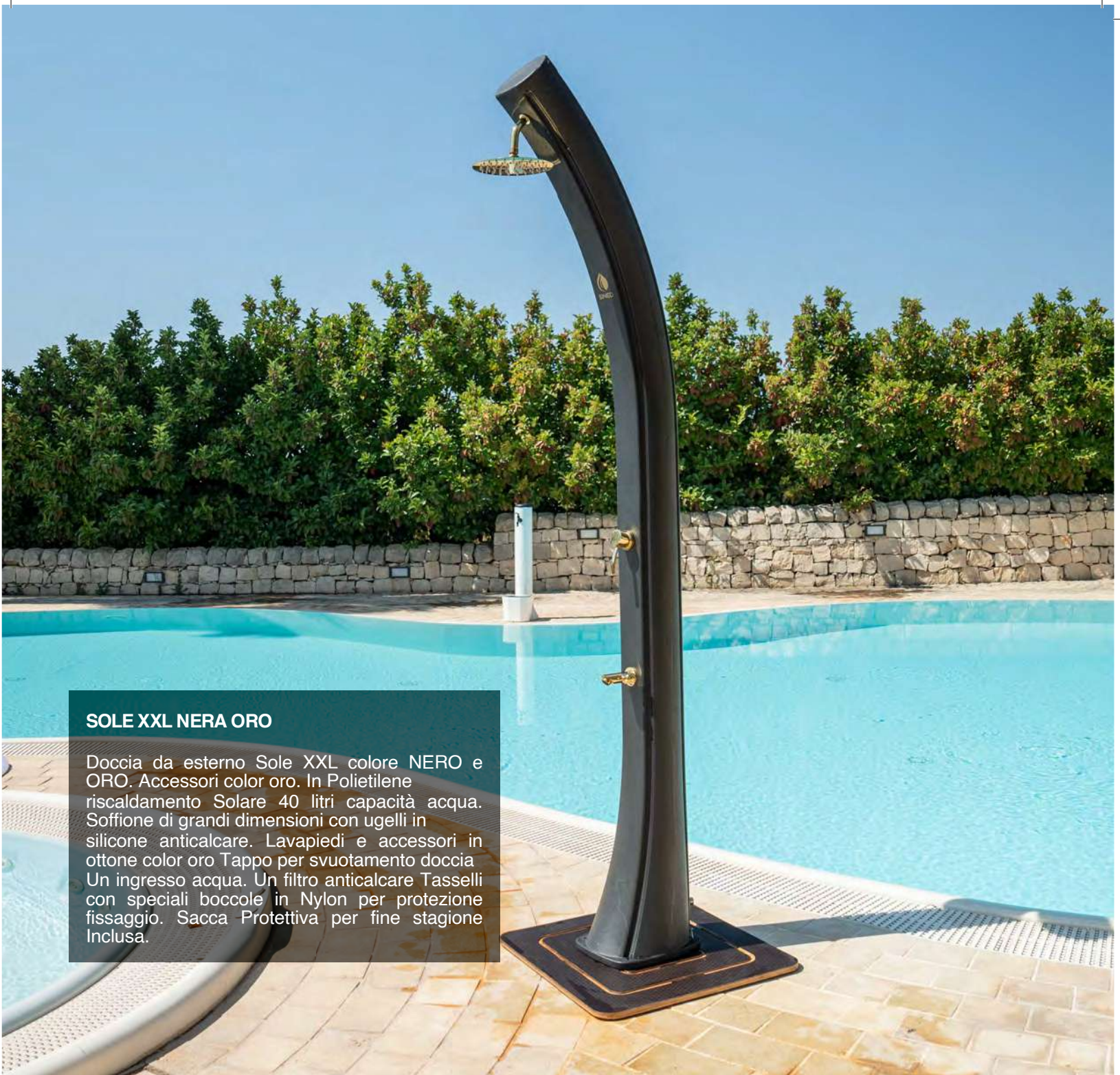

SOLE XXL NERA ORO

Doccia da esterno Sole XXL colore NERO e ORO. Accessori color oro. In Polietilene riscaldamento Solare 40 litri capacità acqua. Soffione di grandi dimensioni con ugelli in silicone anticalcare. Lavapiedi e accessori in ottone color oro Tappo per svuotamento doccia Un ingresso acqua. Un filtro anticalcare Tasselli con speciali boccole in Nylon per protezione fissaggio. Sacca Protettiva per fine stagione Inclusa.

DEUTSCH

Solar-Außendusche Sole XXL Luce aus Polyethylen Farbe Schwarz mit goldfarbenen Armaturen - Solarheizung – 40 Liter Wassertank.

Großer Duschkopf mit Anti-Kalk-Silikondüsen.

Fußwaschhahn und Zubehör aus Messing Farbe Schwarz Matt, Einfüllhahn und Ablaufstopfen zum Entleeren der Dusche, Anti-Kalk-Filter.

Dübel mit speziellen Nylonbuchsen zum Schutz der Dusche bei Aufbau und Gebrauch, Schutzhülle inbegriffen

FRANÇAIS

Douche extérieure SOLE XXL couleur NOIR et accessoires couleur or. En polyéthylène chauffage solaire capacité de 40 litres d'eau.

Grande pomme de douche avec buses en silicone anticalcaire

Lave-pieds et accessoires en laiton couleur or. Bouchon de vidange de douche

Une connexion d'eau. Un filtre anticalcaire

Bouchons avec bagues en nylon spéciales pour la protection pendant le montage et l'utiles Sac de protection pour la fin de la saison

ENGLISH

Outdoor shower Sole XXL in BLACK with accessories in gold color. In Polyethylene solar heating 40 liters water capacity.

Large shower head with anti-limescale silicone nozzles

Foot wash and accessories in brass color gold Shower drain plug

Tap for inlet filling. An anti-limescale filter

Plugs with special nylon bushings for fixing protection Protective bag for end of season

ESPAÑOL

Ducha exterior Sole XXL color negro oro en Polietileno calefacción solar 40 litros de capacidad de agua.

Ducha grande con boquillas de silicona anticalcárea

Lavapiés y accesorios en latón color oro Tapón de desagüe para ducha

Grifo para el llenado de la entrada 1 Filtro anticalcáreo

Tapones con casquillos de nylon especiales para la protección de la fijación Bolsa de protección para el final de la temporada

DOCCIA-SOLE-XXL-NERA-ORO

SOLE XXL BLACK GOLD

8025431017511



COLLEGAMENTO ACQUA LATERALE
1/2" SIDE WATER CONNECTION

ACCESSORI IN OTTONE BLACK MATT. ACCESSORIES MADE OF BRASS



DOCCIA RISCALDAMENTO SOLARE
SOLAR HEATING SHOWER

INCLUDE UNA SACCA DI PROTEZIONE
INCLUDES PROTECTIVE BAG



FILTRO ANTICALCARE ESTERNO
INCLUSO EXTERNAL ANTI-SCALE FILTER INCLUDED

CAPACITÀ DEL SERBATOIO 40 L
TANK CAPACITY 40 L



UGELLI ANTICALCARE
ANTI-SCALE NOZZLES

TUBO INTERNO IN TEFLON FINO A 12 KG DI PRESSIONE
TEFLON INNER TUBE UP TO 12 KG OF PRESSURE



TAPPO DI DRENAGGIO
DRAINING PLUG

BOCCOLE IN NYLON RINFORZATO PER UN MIGLIORE FISSAGGIO AL SUOLO
REINFORCED NYLON BUSHINGS FOR BETTER GROUND FIXATION



IL DOPPIO DELLO SPES-SORE. PIÙ RESISTENTE.
TWICE AS THICK. MORE RESISTANT.

COLLEGAMENTO ALL'AC-QUA IN UN SOLO TUBO
CONNECTION TO WATER IN ONLY 1 PIPE



VALVOLA DI INTERCETTA-ZIONE DELL'ACQUA
WATER SHUT-OFF VALVE



POLIETILENE HD
POLYETHYLENE HD

PESO
13,5 Kg

COLORE
Nero - oro **RAL 9017**

LITRI
40



PROLUNGA DEL SOFFIONE PERMETTE DI ORIENTARLO MEGLIO
SHOWER HEAD EXTENSION ALLOWS FOR BETTER ORIENTATION

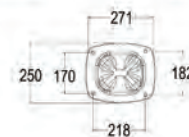
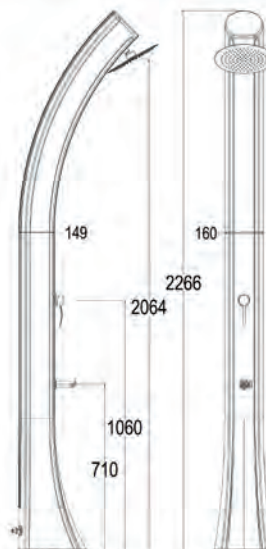
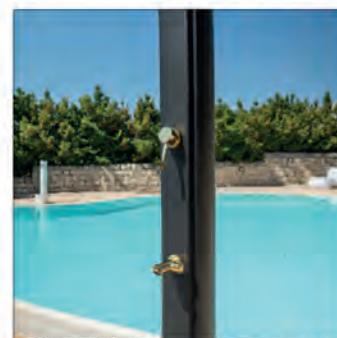

FONTANE DA GIARDINO SINED

Le fontane da esterno di design Sined sono l'elemento ideale per arricchire uno spazio esterno pieno di vita e fantasia, tanto da diventare il punto focale di tutto il giardino.

Si possono acquistare in varie misure, tutte di alta qualità. Sono realizzati in polietilene HD e hanno speciali raccordi in metallo nero opaco.

A seconda del modello, le fontane sono dotate di accessori speciali come secchi e tubi di irrigazione.

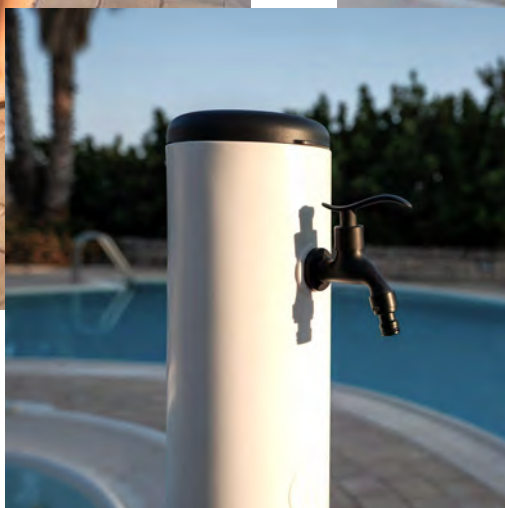
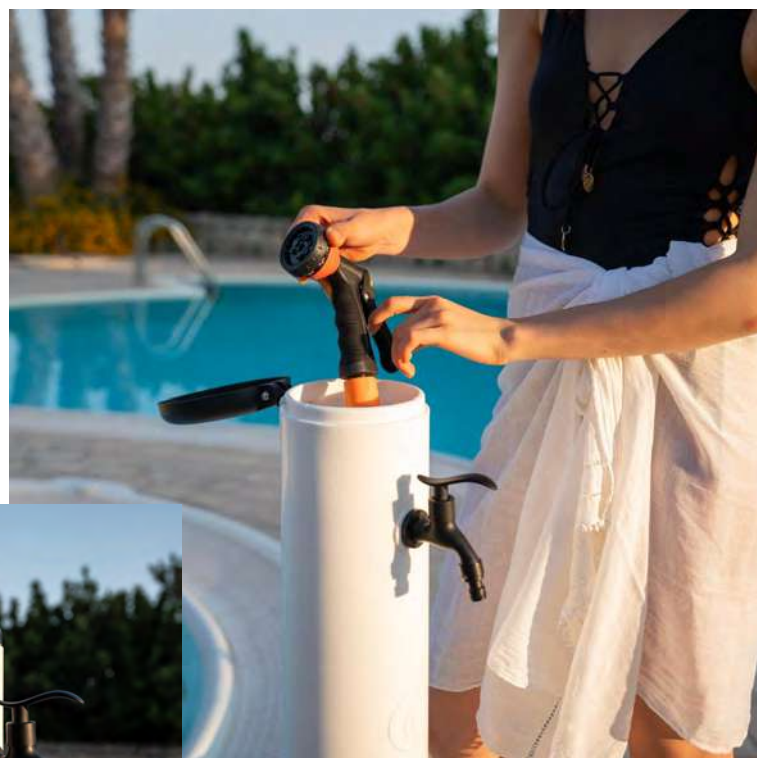
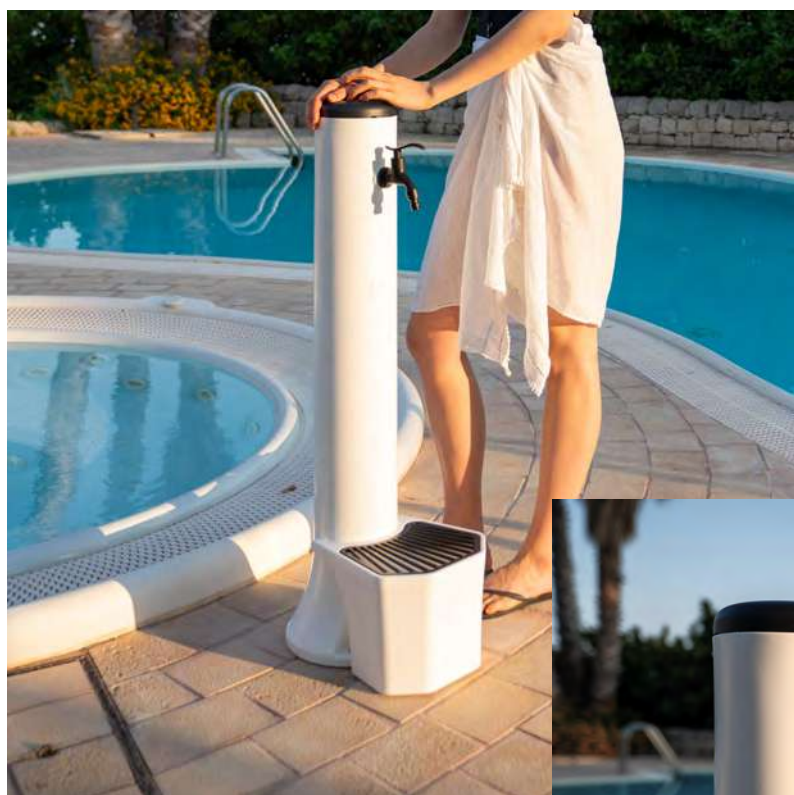

Sined's designer outdoor fountains are the ideal element to enrich an outdoor space full of life and fantasy, so much so that they become the focal point of the entire garden.

They are available in various sizes, all of high quality. They are made of HD polyethylene and have special matt black metal fittings.

Depending on the model, the fountains are equipped with special accessories such as buckets and irrigation hoses.

Las fuentes de exterior de diseño de Sined son el elemento ideal para enriquecer un espacio exterior lleno de vida y fantasía, tanto que se convierten en el punto focal de todo el jardín.

Están disponibles en varios tamaños, todos de alta calidad. Están fabricadas en polietileno de alta densidad y cuentan con accesorios especiales de metal negro mate.

Según el modelo, las fuentes están equipadas con accesorios especiales, como cubos y mangueras de riego.

Les fontaines d'extérieur design de Sined sont l'élément idéal pour enrichir un espace extérieur plein de vie et de fantaisie, au point de devenir le point focal de tout le jardin.

Elles sont disponibles en différentes tailles, toutes de grande qualité. Elles sont fabriquées en polyéthylène HD et sont dotées de raccords métalliques spéciaux noirs mats.

Selon le modèle, les fontaines sont équipées d'accessoires spéciaux tels que des seaux et des tuyaux d'irrigation.

Die Designer-Brunnen von Sined sind das ideale Element, um einen Außenbereich voller Leben und Fantasie zu bereichern, so dass sie zum Mittelpunkt des gesamten Gartens werden.

Sie sind in verschiedenen Größen erhältlich, alle von hoher Qualität. Sie sind aus HD-Polyethylen gefertigt und haben spezielle mattschwarze Metallbeschlüge.

Je nach Modell sind die Springbrunnen mit speziellem Zubehör wie Eimern und Bewässerungsschläuchen ausgestattet.



FONTANA ACQUA

Fontana da Giardino ACQUA struttura Dritta in Polietilene HD

- Ideale per giardini piscine spiagge aree cani
- Altezza 100 cm
- Diametro 8 cm
- Rubinetto in lega metallica nera Black Matt
- Predisposizione per attacchi rapidi tubo da giardino
- Tasselli di fissaggio inclusi
- Tubi interni da 15 Kgs intrecciati e metallici
- Ingresso acqua laterale

DEUTSCH

Gartenbrunnen ACQUA
geradlinige Struktur aus HD-
Polyethylen

- Höhe 100 cm
- Durchmesser 8 cm
- Wasserhahn aus
Metalllegierung, schwarz matt
- Vorgeüstet für
Schnellanschluss von
Gartenschläuchen

FRANÇAIS

Fontaine de jardin ACQUA
structure droite en polyéthylène
HD

- Hauteur 100 cm
- Diamètre 8 cm
- Robinet en alliage métallique
noir mat
- Predisposition pour les
raccords de tuyaux de jardin
- Entrée d'eau latérale

ENGLISH

Garden Fountain ACQUA
straight structure in
Polyethylene HD

- Height 100 cm
- Diameter 8 cm
- Black Matt metal alloy tap
- Water connection at side

ESPAÑOL

Fuente de jardín ACQUA
estructura recta en polietileno
HD

- Altura 100 cm
- Diámetro 8 cm
- Grifo de aleación metálica
negro Black Matt
- Predisposición para
acoplamiento de mangueras de
jardín
- Entrada de agua lateral

FONTANA-ACQUA

8025431018044



FONTANA-ACQUA-
BIANCA
8025431018044



FONTANA-ACQUA-
NERO
8025431017825



FONTANA-ACQUA-
ROSSO
8025431018051



FONTANA-ACQUA-
TORTORA
8025431018068



FONTANA-ACQUA-
VERDE
8025431018068

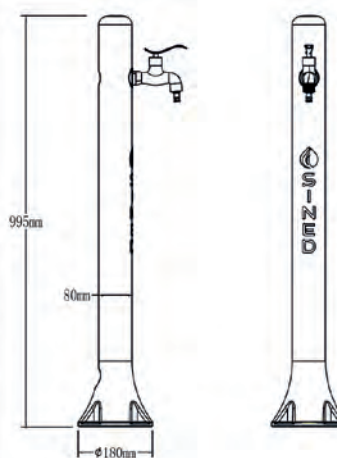

DIMENSIONI

H 100cm - Ø 15cm

COLORE

- Bianco - RAL 9003 ○
- Nero - RAL 9017 ●
- Rosso - RAL 3028 ●
- Tortora - RAL 7030 ●
- Verde - RAL 6016 ●

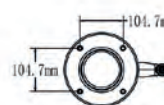



FONTANA ACQUA PRO

Fontana da Giardino ACQUA PRO struttura Dritta in Polietilene HD

- Altezza 100 cm
- Diametro 8 cm
- Rubinetto in lega metallica nera Black Matt
- Predisposizione per attacchi rapidi tubo da giardino
- Tubo flessibile 7,5 mt esterno
- Pistola a spruzzo 8 getti diversi
- Supporto metallico per tubo da giardino
- Tasselli di fissaggio inclusi
- Tubi interni da 15 Kgs intrecciati metallici
- Ingresso acqua laterale

DEUTSCH

- Höhe 100 cm
- Durchmesser 8 cm
- Wasserhahn aus Metalllegierung, schwarz matt
- Vorgerüstet für Schnellanschluss von Gartenschläuchen
- Externer 7,5 m langer flexibler Schlauch
- Spritzpistole mit 8 verschiedenen Düsen
- Metallhalterung für Gartenschlauch

FRANÇAIS

- Fontaine de jardin ACQUA PRO structure droite en polyéthylène HD
- Hauteur 100 cm
 - Diamètre 8 cm
 - Robinet en alliage métallique noir mat
 - Predisposition pour les raccords rapides de tuyaux d'arrosage
 - Tuyau flexible externe de 7,5 m
 - Pistolet de pulvérisation d'eau avec 8 jets différents
 - Support métallique pour tuyau d'arrosage

ENGLISH

- Garden Fountain ACQUA PRO straight structure in Polyethylene HD
- Height 100 cm
 - Diameter 8 cm
 - Black Matt metal alloy tap
 - Predisposition for quick connections garden hose
 - Flexible hose 7,5 mt external
 - Spray gun 8 different jets
 - Metal support for garden hose

ESPAÑOL

- Fuente de jardín ACQUA PRO estructura recta en Polietileno HD
- Altura 100 cm
 - Diámetro 8 cm
 - Grifo de aleación metálica negro Black Matt
 - Predisposición para acoplamiento rápidos de mangueras de jardín
 - Tubo flexible externo de 7,5 m
 - Pistola de riego con 8 chorros diferentes
 - Soporte metálico para manguera de jardín
 - Tapones de fijación incluidos

FONTANA-ACQUA-PRO

8025431017955



FONTANA-ACQUA-PRO-BIANCA
8025431017931



FONTANA-ACQUA-PRO-NERO
8025431017948



FONTANA-ACQUA-PRO-ROSSO
8025431017955



FONTANA-ACQUA-PRO-TORTORA
8025431017962



FONTANA-ACQUA-PRO-VERDE
8025431018037

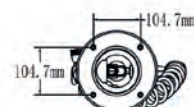
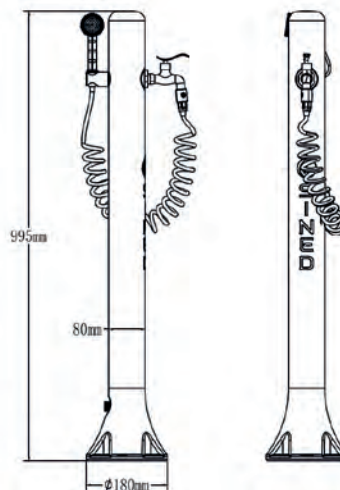
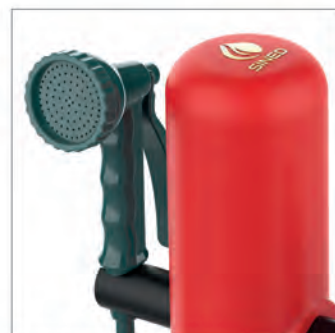

DIMENSIONI

H 100cm - Ø 8cm

COLORE

- Bianco - RAL 9003 ○
- Nero - RAL 9017 ●
- Rosso - RAL 3028 ●
- Tortora - RAL 7030 ●
- Verde - RAL 6016 ●



FONTANA TRITONE

Fontana da Giardino Tritone Struttura Dritta in Polietilene HD

- Corpo Fontana molto robusto
- Altezza 100 cm
- Diametro 15 cm
- Rubinetto in lega metallica nera Black Matt
- Predisposizione per attacchi rapidi tubo da giardino
- Coperchio apribile in alluminio
- Vano interno porta oggetti
- Ingresso acqua laterale o inferiore con valvola a 3 vie

DEUTSCH

Tritone Gartenbrunnen
Geradlinige Struktur aus HD
Polyethylen

- Sehr stabil und solide
- Höhe 100 cm
- Durchmesser 15 cm
- Wasserhahn aus Metalllegierung, schwarz matt
- Vorgerüstet für Schnellanschluss von Gartenschläuchen
- Aufklappbarer Aluminiumdeckel
- Internes Ablagefach
- Seitlicher oder unterer Wasserzulauf mit 3-Wege-Ventil

FRANÇAIS

Fontaine de jardin Tritone
Structure droite en polyéthylène
HD

- Corps de la fontaine très robuste
- Hauteur 100 cm
- Diamètre 15 cm
- Robinet en alliage métallique noir mat
- Predisposition pour les raccords de tuyaux de jardin
- Couvercle en aluminium ouvrable
- Compartiment de rangement interne
- Entrée d'eau latérale ou inférieure avec vanne à 3 voies

ENGLISH

Garden Fountain Tritone
Straight Structure in
Polyethylene HD

- Very Strong Fountain Body
- Height 100 cm
- Diameter 15 cm
- Black Matt metal alloy tap
- Predisposition for garden hose quick couplings
- Opening aluminium lid
- Internal space for objects
- Side or bottom water inlet with 3-way valve

ESPAÑOL

Fuente de jardín Tritone
Estructura recta en Polietileno
HD

- Cuerpo fuente sólido
- Altura 100 cm
- Diámetro 15 cm
- Grifo de aleación metálica negro Black Matt
- Predisposición para acoplamiento de mangueras de jardín
- Tapa de aluminio abatible
- Compartimento de almacenamiento interno
- Entrada de agua lateral o inferior con válvula de 3 vías

FONTANA-TRITONE

8025431017900



FONTANA-TRITONE-BIANCA
8025431017900



FONTANA-TRITONE-NERA
8025431017849



FONTANA-TRITONE-ROSSA
8025431017917



FONTANA-TRITONE-TORTORA
8025431017924



FONTANA-TRITONE-VERDE
8025431017856



SECCHIELLO OPZIONALE

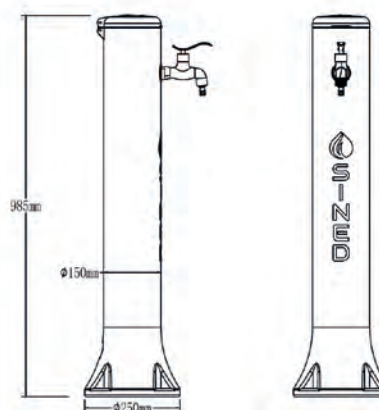

DIMENSIONI

H 100cm - Ø 15cm

COLORE

- Bianco - RAL 9003 ○
- Nero - RAL 9017 ●
- Rosso - RAL 3028 ●
- Tortora - RAL 7030 ●
- Verde - RAL 6016 ●

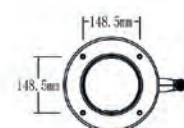



FONTANA TRITONE PRO

Fontana da Giardino Tritone Pro con tubo flessibile e pistola ad 8 getti.

Struttura Dritta in Polietilene HD

- Corpo Fontana molto robusto
- Altezza 100 cm
- Diametro 15 cm
- Rubinetto in lega metallica nera Black Matt
- Predisposizione per attacchi rapidi tubo da giardino
- Coperchio apribile in alluminio
- Alloggiamento interno porta oggetti e tubo flessibile
- Tubo acqua flessibile a spirale 7,5 mt
- Pistola da giardino a spruzzo con 8 getti diversi
- Secchiello in PHD polietilene alta resistenza da 5 litri con griglia in alluminio nera
- Ingresso acqua laterale o inferiore con valvola a 3 vie

DEUTSCH

Gartenbrunnen Tritone Pro mit flexiblem Schlauch und 8 Düsen Spritzpistole

- Geradlinige Struktur aus HD-Polyethylen und Eimer
- Sehr stabil und solide
- Höhe 100 cm
- Durchmesser 15 cm
- Wasserhahn aus Metalllegierung, schwarz matt
- Vorgerüstet für Schnellanschluss von Gartenschläuchen
- Aufklappbarer Aluminiumdeckel
- Internes Schlauch-Ablagefach
- 7,5 m Spiral-Wasserschlauch
- Spritzpistole mit 8 verschiedenen Düsen
- 5-Liter-Eimer aus hochfestem Polyethylen PHD mit Gitter aus Aluminium, Schwarz Matt

- Seitlicher oder unterer Wasserzulauf mit 3-Wege-Ventil

FRANÇAIS

Fontaine de jardin Tritone Pro avec tuyau flexible et buse à 8 jets.

- structure droite HD en polyéthylène
- Corps de fontaine très robuste
- Hauteur 100 cm
- Diamètre 15 cm
- Robinet en alliage métallique noir mat
- Predisposition pour les raccords de tuyaux de jardin
- Couvercle ouvrant en aluminium
- Stockage interne pour les objets et le tuyau
- Tuyau d'eau en spirale de 7,5 m
- Pistolet de jardinage avec 8 jets différents
- Seau PHD de 5 litres en polyéthylène haute résistance avec grille en aluminium noir
- Entrée d'eau latérale ou inférieure avec vanne à 3 voies

ENGLISH

Garden Fountain Tritone Pro with flexible hose and 8 jets gun.

Straight structure in HD Polyethylene

- Very strong fountain body
- Height 100 cm
- Diameter 15 cm
- Black Matt metal alloy tap
- Predisposition for garden hose quick couplings
- Opening aluminium lid
- Internal housing for objects and hose
- Spiral flexible water hose 7,5 mt
- Garden spray gun with 8 different jets
- 5 liter high resistance polyethylene PHD bucket with black aluminium grid
- Side or bottom water inlet with 3-way valve

ESPAÑOL

Fuente de jardín Tritone Pro con manguera flexible y boquilla de 8 chorros.

Estructura recta de Polietileno HD.

- Cuerpo fuente muy robusto
- Altura 100 cm
- Diámetro 15 cm
- Grifo de aleación metálica negro Black Matt
- Predisposición para acoplamiento de mangueras de jardín
- Tapa de apertura de aluminio
- Almacenamiento interno de objetos y mangueras
- Manguera de agua en espiral de 7,5 m
- Pistola de riego con 8 chorros diferentes
- Cubo PHD de polietileno de alta resistencia de 5 litros con rejilla de aluminio negra
- Entrada de agua lateral o inferior con válvula de 3 vías

FONTANA-TRITONE-PRO

8025431017955



FONTANA-TRITONE-PRO-BIANCA
8025431017931



FONTANA-TRITONE-PRO-NERA
8025431018082



FONTANA-TRITONE-PRO-ROSSA
8025431018099



FONTANA-TRITONE-PRO-TORTORA
8025431018105



FONTANA-TRITONE-PRO-VERDE
8025431018112

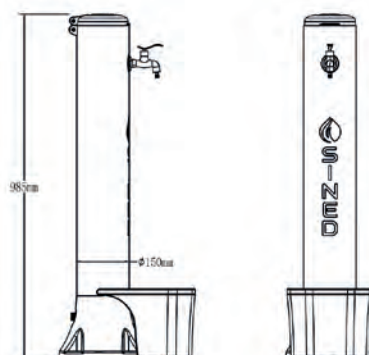

DIMENSIONI

H 100cm - Ø 15cm

COLORE

- Bianco - RAL 9003 ○
- Nero - RAL 9017 ●
- Rosso - RAL 3028 ●
- Tortora - RAL 7030 ●
- Verde - RAL 6016 ●

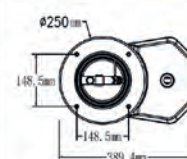



SECCHIELLO TRITONE

Secchiello Fontanella da giardino bianco per fontanelle della serie TRITONE. Abbinabile anche a fontanelle di diverso colore senza problemi, l'unico limite è la tua fantasia. Realizzato in polietilene PHD ad alta resistenza, ideale anche per ambienti marini. Progetto e design italiano, per poter soddisfare le esigenze dei nostri clienti. Con vaschetta recupero acqua con griglia in alluminio raccogli foglie

ESPAÑOL

Fuente de jardín de cubo blanco para fuentes de la serie TRITONE. Se puede combinar también con fuentes de diferentes colores sin problemas, el único límite es su fantasía. Fabricado en polietileno PHD de alta resistencia, apto también para ambientes marinos. Proyecto y diseño italiano, para satisfacer las necesidades de nuestros clientes. Con bandeja de recuperación de agua con rejilla de aluminio para la recogida de hojas

ENGLISH

Bucket garden fountain white for fountains of the series TRITONE. It can be combined also with fountains of different colors without problems, the only limit is your fantasy. Made of polyethylene PHD high resistance, suitable also for marine environments. Italian project and design, to meet the needs of our customers. with water recovery tray with aluminum grid leaves collector

FRANÇAIS

Fontaine de jardin à godet blanc pour les fontaines de la série TRITONE. Elle peut être assortie sans problème à des fontaines de couleurs différentes, la seule limite étant votre fantaisie. Réalisé en polyéthylène PHD à haute résistance, il convient également aux environnements marins. Projet et design italiens, pour répondre aux besoins de nos clients. avec bac de récupération de l'eau avec grille en aluminium pour la récupération des feuilles

DEUTSCH

Eimer Gartenbrunnen weiß für Brunnen der Serie TRITONE. Er lässt sich auch problemlos an Springbrunnen in anderen Farben anpassen, die einzige Grenze ist Ihre Fantasie. Hergestellt aus hochbeständigem PHD-Polyethylen, auch für den Einsatz im Meer geeignet. Italienisches Projekt und Design, um den Bedürfnissen unserer Kunden gerecht zu werden. mit Wasserauffangwanne mit Aluminiumgitter zum Auffangen von Blättern. Kann angepasst

SECCHIELLO-TRITONE

SECCHIELLO-TRITONE-BIANCO

8025431017979



SECCHIELLO-TRITONE-
TORTORA
8025431018006



SECCHIELLO-TRITONE-NERO
8025431017986



SECCHIELLO-TRITONE-
VERDE
8025431018013



SECCHIELLO-TRITONE-
ROSSO
8025431017993

PESO
1,3 KG

COLORE

- Bianco - RAL 9003 ○
- Nero - RAL 9017 ●
- Rosso - RAL 3028 ●
- Tortora - RAL 7030 ●
- Verde - RAL 6016 ●

CHAISE LONGUE SINED

Sdraio e poltrone da bordo piscina o giardino in polietilene o fibra di vetro.

Modelli unici grazie all'eleganza del design e alle sedute ergonomiche.

Lavabili e sanificabili.



*Deckchairs and poolside or garden chairs in polyethylene or fibreglass.
Unique models thanks to the elegance of the design and seats ergonomic seats.
Washable and sanitised.*

*Tumbonas y sillas de piscina o jardín de polietileno o fibra de vidrio.
Modelos únicos por su diseño elegante y sus asientos ergonómicos.
Lavables e higienizables.*

*Chaises longues et chaises de piscine ou de jardin en polyéthylène ou en fibre de verre.
Modèles uniques grâce à leur design élégant et à leurs sièges ergonomiques.
Lavables et désinfectables.*

*Liegestühle und Pool- oder Gartenstühle aus Polyethylen oder Fiberglas.
Einzigartige Modelle dank ihres eleganten Designs und ihrer ergonomischen Sitze.
Waschbar und desinfizierbar.*

ANDROMEADA

Chaise Longue colore bianco da terra modello Andromeda, sedia sdraio realizzata in polietilene ad alta qualità. Lettino prendisole resiste agli UV, ergonomica leggera e facilmente igienizzabile.

Leggera, ambientabile sia per interni che esterni, moderna, sempre di moda. Materiale Polietilene PE polietilene alta qualità. Dimensioni 168x60x67 cm. Peso 17 kg. Resistente a temperature estreme: -60 °C a + 80 °C. Resistente AI RAGGI UV



DEUTSCH

Fußbodenmontierte weiß
Chaiselongue Modell Andromeda,
Sonnenliege aus hochwertigem
Polyethylen. Sonnenliege UV-
beständig, ergonomisch, leicht
und einfach zu reinigen.

Hauptmerkmale. Leicht, für den
Innen- und Außenbereich
geeignet, modern, immer in
Mode. Material Hochwertiges PE-
Polyethylen

Abmessungen 168x60x67
Zentimeter. Gewicht 17 kg.
Beständig gegen extreme
Temperaturen: -60 °C bis 80 °C.

Beständig gegen UV-Strahlen.
Hohe Zugfestigkeit

FRANÇAIS

Chaise longue blanc au sol
modèle Andromeda, bain de
soleil en polyéthylène de haute
qualité.

La chaise longue est résistante
aux UV, ergonomique, légère et
facile à nettoyer.

Légèreté, convient à une
utilisation intérieure et
extérieure, moderne, toujours à
la mode.

Matériau Polyéthylène PE de
haute qualité
Dimensions 168x60x67 cm.
Poids 17 kg.
Résistant aux températures
extrêmes : -60 °C à 80 °C

ENGLISH

Floor standing chaise longue in
white colour model Andromeda,
deckchair made of high quality
polyethylene. Sun lounger UV
resistant, ergonomic, light and
easy to clean.

Lightweight, suitable for both
indoor and outdoor use, modern,
always in fashion. Material High
quality PE polyethylene
Dimensions 168x60x67 cm.
Weight 17 kg.
Resistant to extreme
temperatures: -60 °C to 80 °C
Resistant to UV RAYS

ESPAÑOL

Chaise longue blanco de suelo
modelo Andromeda, tumbona
de polietileno de alta calidad.
Tumbona resistente a los rayos
UV, ergonómica, ligera y fácil de
limpiar.

Ligera, apta para uso en
interiores y exteriores, moderna,
siempre a la moda.
Material Polietileno de alta
calidad
Dimensiones 168x60x67 cm.
Peso 17 kg.
Resistente a temperaturas
extremas: -60 °C a 80 °C
Resistente a los rayos UV

CHAISE-LONGUE-ANDROMEDA

8025431017399

**GALLEGGIANO SULL'ACQUA.
POSSIBILITÀ DI RIEMPIRLI
D'ACQUA.**

*FLOAT ON WATER. POSSIBILITY TO
FILL THEM WITH WATER.*

**REALIZZATE IN POLIETILENE PER USO
ALIMENTARE**

MADE OF POLYETHYLENE FOR FOOD USE.

**LED OPZIONALE PER ILLUMINARE LE
SDRAIO DI NOTTE**

*OPTIONAL LED SPOTLIGHT TO
ILLUMINATE THE SUN LOUNGER AT
NIGHT*

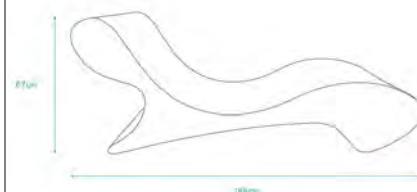

DIMENSIONI

168x60x67 (cm)

PESO

17 kg

COLORE

Bianco

MATERIALE

PE HD



CASSIOPEA

Chaise Lounge Bianca da piscina, giardino, mare realizzato in polietilene di alta qualità, resiste agli UV, ergonomica leggera e facilmente igienizzabile. Design moderno per tutti gli ambienti esterni e interni. Chaise longue anatomicamente studiata per dare il massimo comfort per il corpo. Possibilità di essere usata in acqua, galleggia. Ottima per Mare, spiaggia, piscina, giardino, casa, balcone, esterno, patio, hotel, spa

1. CE, certificazione
2. Design, moderno
3. Alta qualità e lusso
4. Stampaggio unico
5. Prezzo più basso e servizio rapido
6. Ottima per essere destinata all'aperto
7. Colore: bianco
8. Materiale: PE alta qualità
9. Dimensioni :212x89x74 cm
10. Peso :22 kg

DEUTSCH

Weißer Pool-, Garten- und Strandliege aus hochwertigem Polyethylen, UV-beständig, ergonomisch, leicht und einfach zu desinfizieren. Modernes Design für alle Außen- und Innenbereiche. Anatomisch geformte. Chaiselongue für maximalen Körperkomfort.

1. CE, Zertifizierung
2. Design, modern
3. Hohe Qualität und Luxus
4. Einzigartige Formgebung
5. Niedrigster Preis und schneller Service
6. Gut für den Außeneinsatz
7. Farbe: weiß
8. Material: Hochwertiges PE
9. Abmessungen :212x89x74 cm
10. Gewicht :22 kg

FRANÇAIS

Solarium blanc pour piscine, jardin, plage, en polyéthylène de haute qualité, résistant aux UV, ergonomique, léger et facilement nettoyable. Un design moderne pour tous les environnements extérieurs et intérieurs. Chaise longue anatomiquement conçue pour un confort corporel maximal.

1. CE, certification
2. Design, moderne
3. Haute qualité et luxe
4. Moulage unique
5. Prix le plus bas et service rapide
6. Bon pour une utilisation en extérieur
7. Couleur : blanc
8. Matériau : PE de haute qualité
9. Dimensions :212x89x74 cm
10. Poids : 22 kg

ENGLISH

Swimming pool sunbed white, garden, sea made of high quality polyethylene, UV resistant, ergonomic lightweight and easily sanitized. Modern design for all outdoor and indoor environments. Chaise longue anatomically designed to give maximum comfort to the body.

1. CE, certification
2. Design, modern
3. High quality and luxury
4. Unique moulding
5. Lowest price and fast service
6. Good for outdoor use
7. Colour :white
8. Material : high quality PE
9. Dimensions :212x89x74 cm
10. Weight :22 kg

ESPAÑOL

Tumbona blanca para piscina, jardín, playa, fabricada en polietileno de alta calidad, resistente a los rayos UV, ergonómica, ligera y fácilmente higienizable. Diseño moderno para todos los ambientes exteriores e interiores. Chaise longue de diseño anatómico para un máximo confort del cuerpo.

1. CE, certificación
2. Diseño, moderno
3. Alta calidad y lujo
4. Moldeado único
5. Precio más bajo y servicio rápido
6. Bueno para uso en exteriores
7. Color :blanco
8. Material : PE de alta calidad
9. Dimensiones :212x89x74 cm
10. Peso :22 kg

CHAISE-LONGUE-CASSIOPEA

8025431017412



**GALLEGGIANO SULL'ACQUA.
POSSIBILITÀ DI RIEMPIRLI
D'ACQUA.**

*FLOAT ON WATER. POSSIBILITY
TO FILL THEM WITH WATER.*

**REALIZZATE IN POLIETILENE PER USO
ALIMENTARE**

MADE OF POLYETHYLENE FOR FOOD USE.

**LED OPZIONALE PER ILLUMINARE LE
SDRAIO DI NOTTE**

*OPTIONAL LED SPOTLIGHT TO
ILLUMINATE THE SUN LOUNGER AT
NIGHT*

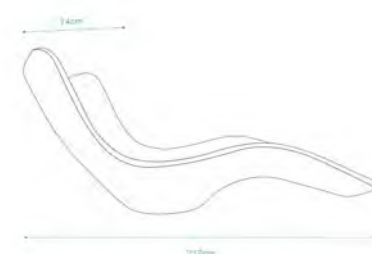

DIMENSIONI

212x89x74 (cm)

PESO

22 Kg

COLORE

Bianca

MATERIALE

PE HD

SIRIO

Accogli i tuoi clienti in modo diverso e unico con la esclusiva chaise longue modello SIRIO. Il colore bianco ben si armonizza in tutti gli ambienti, esterni ed interni. Ottima per tutte le attività balneari o private. Realizzata in PE, polietilene di alta qualità ad un prezzo imbattibile. Resistente alle temperature estreme: da -60 ° c a + 80 ° c e di lunga durata. Possibilità di essere usata in acqua, galleggia. Ottima per Mare, spiaggia, piscina, giardino, casa, balcone, esterno, patio, hotel, spa

1. CE, certificazione
2. Design, moderno
3. Alta qualità e lusso
4. Stampaggio unico
5. Prezzo più basso e servizio rapido
6. Ottima per essere destinata all'aperto
7. Colore: bianco
8. Materiale: PE alta qualità
9. Dimensioni: 178x62x91 cm
10. Peso :18 kg



DEUTSCH

Empfangen Sie Ihre Kunden auf eine andere und einzigartige Weise mit dem exklusiven Chaiselongue-Modell SIRIO. Die weiße Farbe harmonisiert gut mit allen Umgebungen, drinnen und draußen. Hervorragend geeignet für alle Aktivitäten am Meer oder privat. Hergestellt aus PE, hochwertigem Polyethylen zu einem unschlagbaren Preis.

1. CE, Zertifizierung
2. Design, modern
3. Hohe Qualität und Luxus
4. Einzigartige Formgebung
5. Niedrigster Preis und schneller Service
6. Gut für den Außeneinsatz
7. Farbe: weiß
8. Material: Hochwertiges PE
9. Abmessungen: 178x62x91 cm
10. Gewicht :18 kg

FRANÇAIS

Accueillir vos clients d'une manière différente et unique avec le modèle exclusif de chaise longue SIRIO. La couleur blanche s'harmonise bien avec tous les environnements, à l'intérieur comme à l'extérieur. Excellent pour toutes les activités balnéaires ou privées. Fabriqué en PE, polyéthylène de haute qualité à un prix imbattable. Résistant aux températures extrêmes : de 60 ° c à 80 ° c et durable.

1. CE, certification
2. Design, moderne
3. Haute qualité et luxe
4. Moulage unique
5. Prix le plus bas et service rapide
6. Bon pour une utilisation en extérieur
7. Couleur : blanc
8. Matériau : PE de haute qualité
9. Dimensions : 178x62x91 cm
10. Poids : 18 kg

ENGLISH

Welcome your customers in a different and unique way with the exclusive chaise longue model SIRIO. The white color harmonizes well in all environments, outdoor and indoor. Excellent for all beach activities or private. Made of PE, high quality polyethylene at an unbeatable price. Resistant to extreme temperatures: from -60 ° c to 80 ° c and long lasting.

1. CE, certification
2. Design, modern
3. High quality and luxury
4. Unique moulding
5. Lowest price and quick service
6. Good for outdoor use
7. Colour :white
8. Material : high quality PE
9. Dimensions :178x62x91 cm
10. Weight :18 kg

ESPAÑOL

Reciba a sus clientes de una forma diferente y única con la exclusiva chaise longue modelo SIRIO. El color blanco armoniza bien con todos los ambientes, tanto interiores como exteriores. Excelente para todo tipo de actividades marítimas o privadas. Fabricado en PE, polietileno de alta calidad a un precio inmejorable. Resistente a temperaturas extremas: de -60 ° c a 80 ° c y de larga duración.

1. CE, certificación
2. Diseño, moderno
3. Alta calidad y lujo
4. Moldeado único
5. Precio más bajo y servicio rápido
6. Bueno para uso en exteriores
7. Color :blanco
8. Material : PE de alta calidad
9. Dimensiones :178x62x91 cm
10. Peso :18 kg

CHAISE-LONGUE-SIRIO

8025431017436



**GALLEGGIANO SULL'ACQUA.
POSSIBILITÀ DI RIEMPIRLI
D'ACQUA.**

*FLOAT ON WATER. POSSIBILITY TO
FILL THEM WITH WATER.*

**REALIZZATE IN POLIETILENE PER USO
ALIMENTARE**
MADE OF POLYETHYLENE FOR FOOD USE.

**LED OPZIONALE PER ILLUMINARE LE
SDRAIO DI NOTTE**
*OPTIONAL LED SPOTLIGHT TO
ILLUMINATE THE SUN LOUNGER AT
NIGHT*

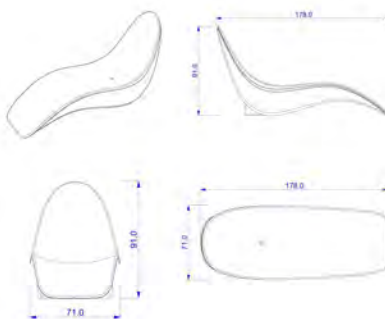

DIMENSIONI
178x62x91 (cm)

PESO
18 Kg

COLORE
Bianco

MATERIALE
PE HD

VENERE

Anatomicamente perfetta questa chaise longue offre il massimo comfort per il corpo. Simbolo di design moderno è stata particolarmente studiata nella sua realizzazione finale per offrire il massimo anche dal punto di vista visivo e tattile. Ideale per tutte le attività sociali e private all'aperto e uso interno, spiaggia, stabilimento balneare, hotel, B e B, casa, giardino, bordo piscina, campeggio. Il design ed il colore la rendono ottima per inserirla in ogni contesto ambientale. Di facile pulizia e igienizzazione.

1. CE,
2. Design, moderno
3. Alta qualità e lusso
4. Tecnologia: fibra di vetro
5. Prezzo più basso e servizio rapido
6. Ottima per essere destinata all'aperto
7. Colore: bianco
8. Dimensioni :178x71x91 cm
9. Peso :20 kg



DEUTSCH

Weiß Loungesessel aus Glasfaser, sehr widerstandsfähig gegen UV-Strahlen. Besonders geeignet als Garten- und Pool-Liege. Abmessungen 178x71x91 cm.

FRANÇAIS

Chaise longue en fibre de verre blanche convenant à un usage intensif en extérieur et en intérieur. Forme anatomique parfaite pour un confort maximal avec des dimensions de 178x71x91 cm. Très résistant aux UV et facile à nettoyer et à entretenir.

ENGLISH

White fibreglass chaise longue suitable for intensive use both outdoors and indoors. Anatomical shape perfect for maximum comfort with dimensions 178x71x91 cm. Very UV resistant and easy to clean and maintain.

ESPAÑOL

Chaise longue de fibra de vidrio blanca apta para uso intensivo en exteriores e interiores. Forma anatómica perfecta para un máximo confort con dimensiones 178x71x91 cm. Muy resistente a los rayos UV y fácil de limpiar y mantener.

CHAISE-LONGUE-VENERE

8025431017450



**REALIZZATE IN FIBRA DI VETRO.
MASSIMA STABILITÀ, CONFORT E
RESISTENZA ALLE PERATURE
ESTREME.**

*MADE OF FIBREGLASS. MAXIMUM
STABILITY, COMFORT AND
RESISTANCE TO EXTREME
PERATURE.*

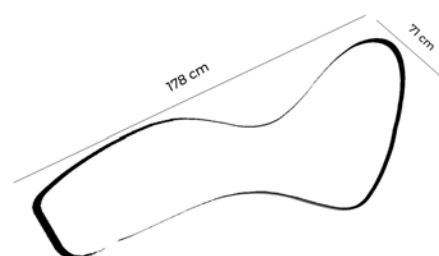

VETRORESINA
FIBREGLASS

DIMENSIONI

178x62x91 (cm)

PESO

18 Kg

COLORE

Bianca

MATERIALE

Vetroresina



ANTARES

Finalmente un chaise longue di ottima qualità, realizzata in vetro resina che resiste ai raggi UV con un uso durevole. Ideale per tutte le attività sociali e private all'aperto e uso interno, spiaggia, stabilimento balneare, hotel, B e B, casa, giardino, bordo piscina, campeggio. L'unico limite è la tua fantasia. Il design ed il colore la rendono ottima per inserirla in ogni contesto ambientale. Di facile pulizia e igienizzazione.

1. CE 2. Design, moderno 3. Alta qualità e lusso 4. Tecnologia: fibra di vetro 5. Ottima per essere destinata all'aperto 6. Colore: bianco 7. Dimensioni :154x63x62 cm 8. Peso :8,5 kg

DEUTSCH

Endlich eine Chaiselongue von hervorragender Qualität, hergestellt aus UV-beständigem und langlebigem Glasharz. Abmessungen 154x63x62, die einen ausgezeichneten Komfort für jedermann bieten.

Ideal für alle sozialen und privaten Outdoor-und Indoor-Gebrauch, Strand, Badeanstalt, Hotel, B und B, Haus, Garten, Pool, Camping.

CE-Zertifizierung
Design, modern
Hohe Qualität und Luxus
Technologie: Glasfaser
Hervorragend geeignet für den Einsatz im Freien
Farbe: weiß
Abmessungen: 154x63x62 cm
Gewicht: 8,5 kg

FRANÇAIS

Enfin une chaise longue d'excellente qualité, fabriquée en résine de verre qui résiste aux rayons UV avec une utilisation durable. Dimensions 154x63x62 qui offrent un excellent confort pour tous.

Idéal pour toute utilisation sociale et privée en extérieur et en intérieur, plage, établissement de bains, hôtel, B and B, maison, jardin, bord de piscine, camping.

Certification CE,
Design, moderne
Haute qualité et luxe
Technologie : fibre de verre
Excellent pour utilisation en extérieur
Couleur: blanc
Dimensions: 154x63x62 cm
Poids : 8,5 kg

ENGLISH

Finally a chaise longue of excellent quality, made of glass resin that resists UV rays with a durable use. Dimensions 154x63x62 that allow an excellent comfort for everyone.

Ideal for all social and private activities outdoor and indoor use, beach, bathing establishment, hotel, B and B, home, garden, poolside, camping.

CE, certification
Design, modern
High quality and luxury
Technology: glass fiber
Lowest price and fast service
Great for outdoor use
Color :white
Dimensions :154x63x62 cm

ESPAÑOL

Por último, una chaise longue de excelente calidad, hecha de resina de vidrio que resiste los rayos UV y es duradera. Dimensiones 154x63x62 que proporcionan una excelente comodidad para todos.

Ideal para todo uso social y privado al aire libre y en interiores, playa, establecimiento de baño, hotel, B and B, casa, jardín, junto a la piscina, camping.

Certificación CE,
Diseño, moderno
Alta calidad y lujo
Tecnología: fibra de vidrio
Excelente para el uso en exteriores
Color: blanco
Dimensiones :154x63x62 cm
Peso: 8,5 kg

CHAISE-LONGUE-ANTARES

8025431017405



**REALIZZATE IN FIBRA DI VETRO.
MASSIMA STABILITÀ, CONFORT E
RESISTENZA ALLE PERATURE
ESTREME.**

*MADE OF FIBREGLASS. MAXIMUM
STABILITY, COMFORT AND
RESISTANCE TO EXTREME
PERATURE.*

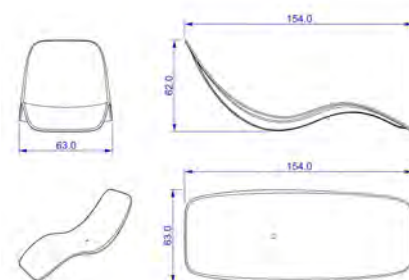

VETRORESINA
FIBREGLASS

DIMENSIONI

154x63x62 (cm)

PESO

16 kg

COLORE

Bianca

MATERIALE

Vetroresina

OGGETTI LUMINOSI SOLARI

Queste meraviglie di tecnologia e design sono la soluzione perfetta per aggiungere un tocco magico e affascinante ai tuoi spazi all'aperto.

Anche quando la luce solare scarseggia, queste oggetti luminosi solari funzionano automaticamente grazie al loro sensore, creando un'atmosfera accogliente e affascinante.



These marvels of technology and design are the perfect solution for adding a magical and charming touch to your outdoor spaces. Even when sunlight is scarce, these solar light objects work automatically thanks to their sensor, creating a cosy and charming atmosphere.

Estas maravillas de la tecnología y el diseño son la solución perfecta para añadir un toque mágico y encantador a sus espacios exteriores.

Incluso cuando la luz solar escasea, estos objetos luminosos solares funcionan automáticamente gracias a su sensor, creando un ambiente acogedor y encantador.

Ces merveilles de technologie et de design sont la solution parfaite pour ajouter une touche de magie et de charme à vos espaces extérieurs.

Même lorsque la lumière du soleil se fait rare, ces objets lumineux solaires fonctionnent automatiquement grâce à leur capteur, créant ainsi une atmosphère chaleureuse et charmante.

Diese Wunderwerke der Technik und des Designs sind die perfekte Lösung, um Ihren Außenbereichen einen magischen und charmanten Touch zu verleihen.

Auch wenn das Sonnenlicht knapp ist, arbeiten diese Solarlichtobjekte dank ihres Sensors automatisch und schaffen eine gemütliche und charmante Atmosphäre.



VASO ROTONDO SOLAR (86 o 102 cm)

Immagina un elemento d'arredo che unisce l'eleganza di un vaso tradizionale per piante con la funzionalità innovativa di un dispositivo di illuminazione: ecco a te il nostro vaso luminoso solare autoricaricabile per esterno. Questa soluzione decorativa rispetta l'ambiente e assicura un'efficienza energetica ottimale.

Questo accessorio unico nel suo genere risplende grazie alle luci LED interne che irradiano una luce dall'interno del vaso. Puoi scegliere se avere un'illuminazione costante o variare colore e intensità a tuo piacimento.

ESPAÑOL

Imagine un mueble que combine la elegancia de una maceta tradicional con la funcionalidad innovadora de un dispositivo de iluminación: nuestra maceta solar para exterior autocargable. Esta solución decorativa respeta el medio ambiente y garantiza una eficiencia energética óptima.

Este accesorio único brilla gracias a las luces LED internas que irradian luz desde el interior de la maceta. Puede elegir entre una iluminación constante o variar el color y la intensidad a su gusto.

ENGLISH

Imagine a piece of furniture that combines the elegance of a traditional plant pot with the innovative functionality of a lighting device: our self-charging solar outdoor light pot. This decorative solution respects the environment and ensures optimal energy efficiency.

This unique accessory shines thanks to internal LED lights that radiate light from inside the pot. You can choose to have constant illumination or vary the colour and intensity to your liking.

FRANÇAIS

Imaginez un meuble qui allie l'élégance d'un pot de fleurs traditionnel à la fonctionnalité innovante d'un dispositif d'éclairage : notre pot de lumière solaire d'extérieur auto-rechargeable. Cette solution décorative respecte l'environnement et assure une efficacité énergétique optimale.

Cet accessoire unique brille grâce à des LED internes qui diffusent la lumière depuis l'intérieur du pot. Vous pouvez choisir d'avoir une illumination constante ou de varier la couleur et l'intensité à votre guise.

DEUTSCH

Stellen Sie sich ein Möbelstück vor, das die Eleganz eines traditionellen Blumentopfs mit der innovativen Funktionalität einer Beleuchtungseinrichtung verbindet: unseren selbstaufladenden Solar-Lichttopf für den Außenbereich. Diese dekorative Lösung respektiert die Umwelt und gewährleistet eine optimale Energieeffizienz.

Dieses einzigartige Accessoire erstrahlt dank interner LED-Leuchten, die das Licht aus dem Inneren des Topfes abstrahlen. Sie können wählen, ob Sie eine konstante Beleuchtung wünschen oder die Farbe und Intensität nach Ihrem Geschmack variieren möchten.

VASO-ROTONDO-SOLAR-86

8025431151147

VASO-ROTONDO-SOLAR-102

8025431151130



VASO-ROTONDO-SOLAR-86



VASO-ROTONDO-SOLAR-102

- *Si ricaricano autonomamente con la Luce solare*
- *Senza dover collegare il cavo di Alimentazione*
- *Accensione e spegnimento automatici*
- *Batteria al Litio e Telecomando Inclusi*

A++ A+ A



COLORE
Bianco

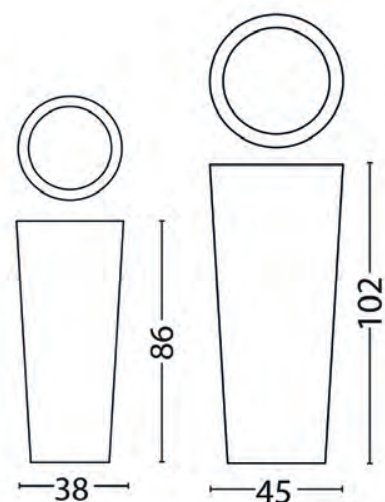



VASO QUADRATO SOLAR (86 o 102cm)

Un vaso luminoso solare autoricaricabile per esterno è una soluzione decorativa eco-friendly ed efficiente dal punto di vista energetico. Questo elemento combina l'estetica tradizionale di un vaso per piante con la funzionalità di un dispositivo di illuminazione.

Questo componente d'arredo unico ed elegante è ideale sia per gli interni che per gli esterni. Contiene luci LED interne che illuminano il vaso dall'interno. L'illuminazione LED può essere costante o impostata per variare colore o intensità.

ESPAÑOL

Una maceta con luz solar para exteriores autocargable es una solución decorativa ecológica y energéticamente eficiente. Este elemento combina la estética tradicional de una maceta con la funcionalidad de un dispositivo de iluminación.

Este componente decorativo único y elegante es ideal tanto para interiores como para exteriores. Contiene luces LED internas que iluminan la maceta desde el interior. La iluminación LED puede ser constante o variable en color o intensidad.

ENGLISH

A self-charging solar outdoor light pot is an eco-friendly and energy-efficient decorative solution. This element combines the traditional aesthetics of a plant pot with the functionality of a lighting device.

This unique and elegant décor component is ideal for both indoor and outdoor use. It contains internal LED lights that illuminate the pot from the inside. The LED lighting can be constant or set to vary in colour or intensity.

FRANÇAIS

Un pot de lumière solaire d'extérieur à chargement automatique est une solution décorative écologique et économe en énergie. Cet élément combine l'esthétique traditionnelle d'un pot de fleurs avec la fonctionnalité d'un dispositif d'éclairage.

Ce composant décoratif unique et élégant est idéal pour une utilisation à l'intérieur comme à l'extérieur. Il contient des lumières LED internes qui éclairent le pot de l'intérieur. L'éclairage LED peut être constant ou varier en couleur ou en intensité.

DEUTSCH

Ein selbstaufladender Solar-Lichttopf für den Außenbereich ist eine umweltfreundliche und energieeffiziente dekorative Lösung. Dieses Element kombiniert die traditionelle Ästhetik eines Blumentopfes mit der Funktionalität einer Beleuchtungseinrichtung.

Dieses einzigartige und elegante Dekorationselement ist sowohl für den Innen- als auch für den Außenbereich geeignet. Es enthält interne LED-Leuchten, die den Topf von innen beleuchten. Die LED-Beleuchtung kann konstant sein oder in Farbe und Intensität variieren.

VASO-QUADRATO-SOLAR-86

8025431151123

VASO-QUADRATO-SOLAR-102

8025431151116



VASO-QUADRATO-SOLAR-86



VASO-QUADRATO-SOLAR-102

- Si ricaricano autonomamente con la Luce solare
- Senza dover collegare il cavo di Alimentazione
- Accensione e spegnimento automatici
- Batteria al Litio e Telecomando Inclusi

A++ A+ A

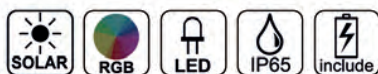

COLORE
Bianco

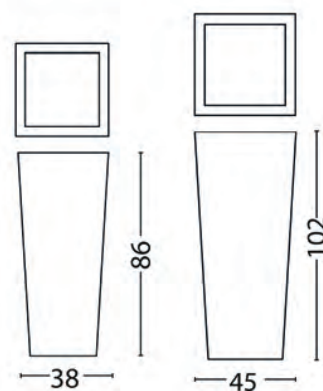

cm



SGABELLO LUMINOSO PAR

Sgabello creato con estrema cura, utilizzando polietilene - un materiale noto per la sua eccellente durabilità e sicurezza. Questo materiale è completamente atossico, garantendo la tua tranquillità quando viene utilizzato in una varietà di ambienti. Ancora più importante, è totalmente riciclabile, il che ci aiuta a ridurre il nostro impatto sull'ambiente e a sostenere uno stile di vita più sostenibile. Uno dei principali vantaggi del polietilene è la sua straordinaria resistenza alle variazioni di temperatura. Può resistere a temperature che vanno da -60° a +80°, rendendolo incredibilmente versatile e adatto a una vasta gamma di condizioni climatiche.

ESPAÑOL

Taburete creado con gran cuidado, utilizando polietileno - un material conocido por su excelente durabilidad y seguridad. Este material es totalmente atóxico, lo que garantiza su tranquilidad cuando se utiliza en diversos entornos. Y lo que es más importante, es totalmente reciclable, lo que nos ayuda a reducir nuestro impacto en el medio ambiente y a apoyar un estilo de vida más sostenible.

Una de las principales ventajas del polietileno es su extraordinaria resistencia a las variaciones de temperatura. Puede soportar temperaturas que oscilan entre -60° y +80°, lo que lo hace increíblemente versátil y adecuado para una amplia gama de condiciones climáticas.

ENGLISH

Stool created with great care, using polyethylene - a material known for its excellent durability and safety. This material is completely non-toxic, ensuring your peace of mind when used in a variety of environments. More importantly, it is fully recyclable, which helps us reduce our impact on the environment and support a more sustainable lifestyle.

One of the main advantages of polyethylene is its extraordinary resistance to temperature variations. It can withstand temperatures ranging from -60° to +80°, making it incredibly versatile and suitable for a wide range of climatic conditions.

FRANÇAIS

Tabouret créé avec le plus grand soin, en utilisant du polyéthylène - un matériau connu pour son excellente durabilité et sa sécurité. Ce matériau est totalement non toxique, ce qui garantit votre tranquillité d'esprit lorsqu'il est utilisé dans divers environnements. Plus important encore, il est entièrement recyclable, ce qui nous aide à réduire notre impact sur l'environnement et à soutenir un mode de vie plus durable.

L'un des principaux avantages du polyéthylène est son extraordinaire résistance aux variations de température. Il peut supporter des températures allant de -60° à +80°, ce qui le rend incroyablement polyvalent et adapté à un large éventail de conditions climatiques.

DEUTSCH

Hocker, der mit großer Sorgfalt aus Polyethylen hergestellt wird - einem Material, das für seine hervorragende Haltbarkeit und Sicherheit bekannt ist. Dieses Material ist völlig ungiftig, so dass Sie es unbesorgt in einer Vielzahl von Umgebungen verwenden können. Noch wichtiger ist, dass es vollständig recycelbar ist, was dazu beiträgt, die Auswirkungen auf die Umwelt zu verringern und einen nachhaltigeren Lebensstil zu unterstützen.

Einer der Hauptvorteile von Polyethylen ist seine außerordentliche Widerstandsfähigkeit gegenüber Temperaturschwankungen. Es kann Temperaturen von -60° bis +80° standhalten und ist damit unglaublich vielseitig und für ein breites Spektrum an klimatischen Bedingungen geeignet.

SGABELLO-LUMINOSO-KAMIS

8025431151086

SGABELLO-LUMINOSO-PAR

8025431151093



SGABELLO-LUMINOSO-KAMIS



SGABELLO-LUMINOSO-PAR

- *Si ricaricano autonomamente con la Luce solare*
- *Senza dover collegare il cavo di Alimentazione*
- *Accensione e spegnimento automatici*
- *Batteria al Litio e Telecomando Inclusi*

A++ A+ A

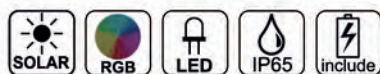

COLORE
Bianco

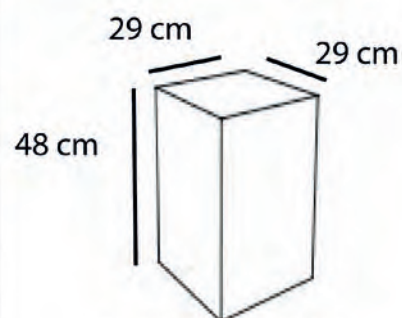

SGABELLO-LUMINOSO-PAR

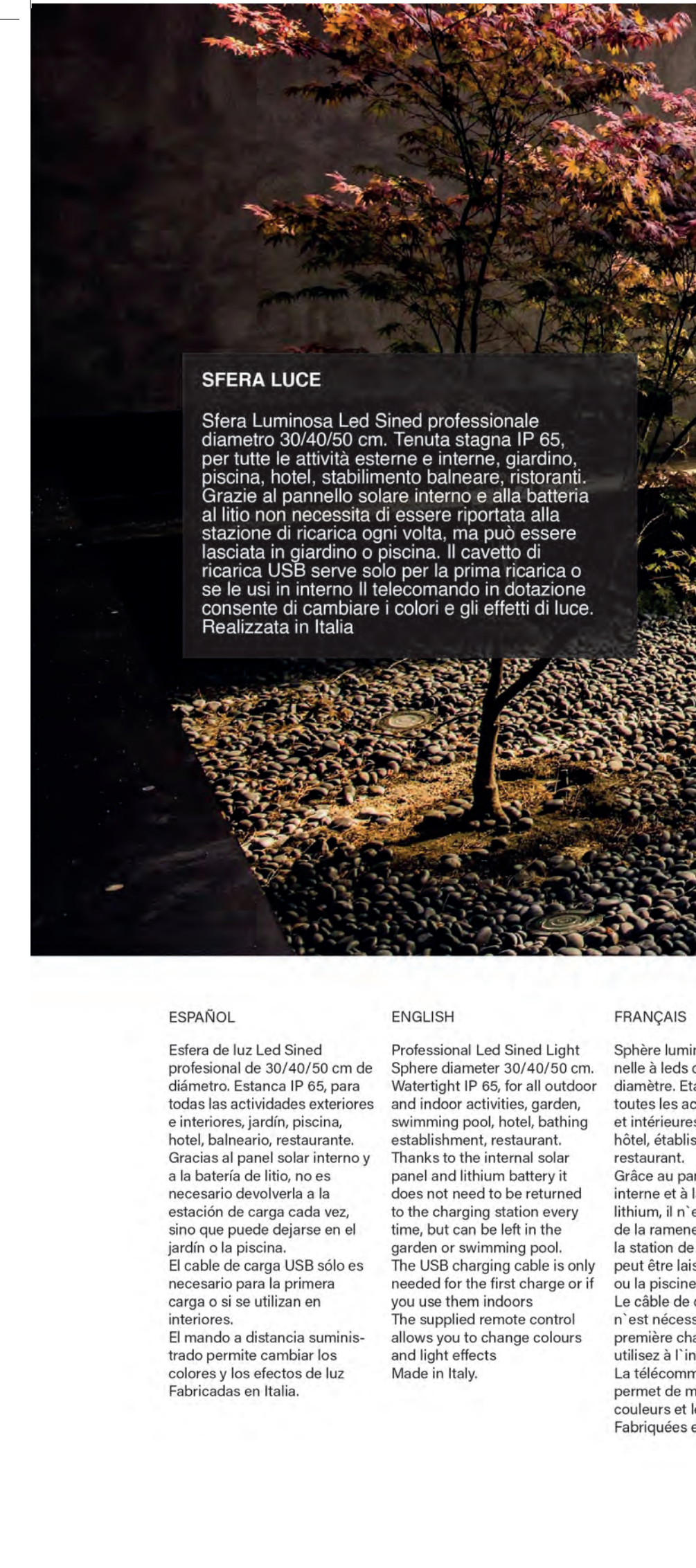

SFERA LUCE

Sfera Luminosa Led Sined professionale diametro 30/40/50 cm. Tenuta stagna IP 65, per tutte le attività esterne e interne, giardino, piscina, hotel, stabilimento balneare, ristoranti. Grazie al pannello solare interno e alla batteria al litio non necessita di essere riportata alla stazione di ricarica ogni volta, ma può essere lasciata in giardino o piscina. Il cavetto di ricarica USB serve solo per la prima ricarica o se le usi in interno Il telecomando in dotazione consente di cambiare i colori e gli effetti di luce. Realizzata in Italia

ESPAÑOL

Esfera de luz Led Sined profesional de 30/40/50 cm de diámetro. Estanca IP 65, para todas las actividades exteriores e interiores, jardín, piscina, hotel, balneario, restaurante. Gracias al panel solar interno y a la batería de litio, no es necesario devolverla a la estación de carga cada vez, sino que puede dejarse en el jardín o la piscina. El cable de carga USB sólo es necesario para la primera carga o si se utilizan en interiores. El mando a distancia suministrado permite cambiar los colores y los efectos de luz. Fabricadas en Italia.

ENGLISH

Professional Led Sined Light Sphere diameter 30/40/50 cm. Watertight IP 65, for all outdoor and indoor activities, garden, swimming pool, hotel, bathing establishment, restaurant. Thanks to the internal solar panel and lithium battery it does not need to be returned to the charging station every time, but can be left in the garden or swimming pool. The USB charging cable is only needed for the first charge or if you use them indoors. The supplied remote control allows you to change colours and light effects. Made in Italy.

FRANÇAIS

Sphère lumineuse professionnelle à leds de 30/40/50 cm de diamètre. Etanche IP 65, pour toutes les activités extérieures et intérieures, jardin, piscine, hôtel, établissement de bains, restaurant. Grâce au panneau solaire interne et à la batterie au lithium, il n'est pas nécessaire de la ramener à chaque fois à la station de charge, mais elle peut être laissée dans le jardin ou la piscine. Le câble de chargement USB n'est nécessaire que pour la première charge ou si vous les utilisez à l'intérieur. La télécommande fournie permet de modifier les couleurs et les effets lumineux. Fabriquées en Italie.

DEUTSCH

Professionelle Led Sined Light Sphere Durchmesser 30/40/50 cm. Wasserdicht IP 65, für alle Außen- und Innenaktivitäten, Garten, Schwimmbad, Hotel, Badeanstalt, Restaurant. Dank des internen Solarpanels und der Lithium-Batterie muss sie nicht jedes Mal zur Ladestation zurückgebracht werden, sondern kann im Garten oder im Schwimmbad gelassen werden. Das USB-Ladekabel wird nur für die erste Aufladung benötigt oder wenn Sie sie in Innenräumen verwenden. Mit der mitgelieferten Fernbedienung können Sie die Farben und Lichteffekte verändern. Hergestellt in Italien.

SFERA-LUCE-30

8025431151048

SFERA-LUCE-40

8025431151055

SFERA-LUCE-50

8025431151185



SFERA-LUCE-30

SFERA-LUCE-40



SFERA-LUCE-50

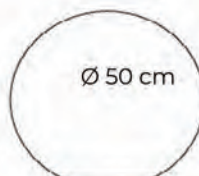



- Si ricaricano autonomamente con la Luce solare
- Senza dover collegare il cavo di Alimentazione
- Accensione e spegnimento automatici
- Batteria al Litio e Telecomando Inclusi

A++ A+ A

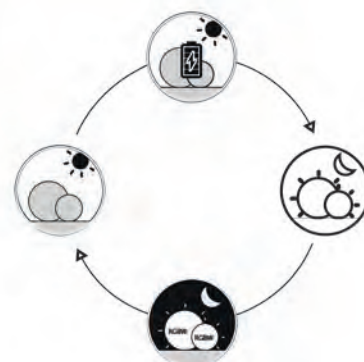

PESO
2 KG
COLORE
Bianco





TAVOLINO LUMINOSO CUBY

Il nostro tavolino luminoso CUBY, attentamente concepito e prodotto con polietilene di alta qualità, è sinonimo di durabilità e sicurezza eccellenti. Questo materiale atossico assicura un utilizzo sereno in molteplici situazioni. Inoltre, il suo attributo riciclabile contribuisce alla riduzione del nostro impatto ambientale e favorisce uno stile di vita più ecocompatibile.

Il polietilene si distingue per la sua sorprendente resistenza alle variazioni di temperatura, con un range che va da -60° a +80°. Questa qualità lo rende incredibilmente versatile, adattandosi a una vasta gamma di condizioni atmosferiche.

ESPAÑOL

Nuestra mesa de luz CUBY, cuidadosamente diseñada y fabricada en polietileno de alta calidad, es sinónimo de excelente durabilidad y seguridad. Este material no tóxico garantiza un uso sereno en diversas situaciones. Además, su atributo reciclable contribuye a reducir nuestro impacto medioambiental y promueve un estilo de vida más respetuoso con el medio ambiente.

El polietileno se distingue por su asombrosa resistencia a las variaciones de temperatura, con un rango de -60° a +80°. Esta cualidad lo hace increíblemente versátil, adaptándose a una amplia gama de condiciones climáticas.

ENGLISH

Our CUBY light table, carefully designed and manufactured from high-quality polyethylene, stands for excellent durability and safety. This non-toxic material ensures serene use in a variety of situations. Furthermore, its recyclable attribute contributes to the reduction of our environmental impact and promotes a more eco-friendly lifestyle.

Polyethylene is distinguished by its amazing resistance to temperature variations, with a range from -60° to +80°. This quality makes it incredibly versatile, adapting to a wide range of weather conditions.

FRANÇAIS

Notre table lumineuse CUBY, soigneusement conçue et fabriquée en polyéthylène de haute qualité, est synonyme d'excellente durabilité et de sécurité. Ce matériau non toxique garantit une utilisation sereine dans diverses situations. En outre, son caractère recyclable contribue à réduire notre impact sur l'environnement et à promouvoir un mode de vie plus respectueux de l'environnement.

Le polyéthylène se distingue par son étonnante résistance aux variations de température, dans une fourchette allant de -60° à +80°. Cette qualité le rend incroyablement polyvalent et lui permet de s'adapter à un large éventail de conditions météorologiques.

DEUTSCH

Unser CUBY-Leuchttisch, sorgfältig entworfen und hergestellt aus hochwertigem Polyethylen, steht für ausgezeichnete Haltbarkeit und Sicherheit. Dieses ungiftige Material gewährleistet eine ruhige Nutzung in einer Vielzahl von Situationen. Darüber hinaus trägt es durch seine Recyclingfähigkeit dazu bei, die Umweltbelastung zu verringern und einen umweltfreundlicheren Lebensstil zu fördern.

Polyethylen zeichnet sich durch seine erstaunliche Widerstandsfähigkeit gegenüber Temperaturschwankungen aus, mit einem Bereich von -60° bis +80°. Diese Eigenschaft macht es unglaublich vielseitig und passt sich den unterschiedlichsten Wetterbedingungen an.

TAVOLINO-LUMINOSO-CUBY

8025431151109



- *Si ricaricano autonomamente con la Luce solare*
- *Senza dover collegare il cavo di Alimentazione*
- *Accensione e spegnimento automatici*
- *Batteria al Litio e Telecomando Inclusi*

A++ A+ A



COLORE
Bianco

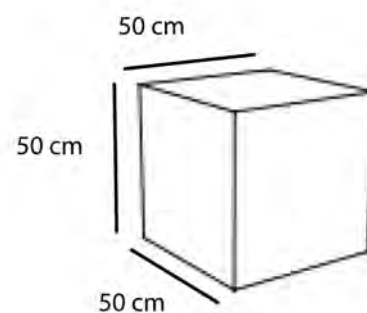



Italia: M.P.C. Srl
Via Tortona 21 20144 Milano, Italia

Logistica: Gruppo Sinergia
Via Tavole di Casalbergo 7
37063 Isola della Scala (VR)

España: Sined V.O. S.L.U.
Avenida Diagonal, 413 5º 2ª
08008 Barcelona España

Logistica: Stockabee
Calle Tapiceros 5 Nave K
28830 San Fernando de Henares Madrid

☎ **TELEFONO IT +39 0221117815**
MOBILE IT +39 335 7600875
MOBILE EN/FR +39 3425447140
TELÉFONO ES +34 664 66 64 26
TELÉFONO ES +34 664 66 64 28

🌐 **SINEDITALIA.COM**
POOL-SHOWERS.COM
DOCCIAPISCINA.IT
DUCHAEXTERIOR.ES

✉ **INFO@SINEDITALIA.COM**

Si ringrazia l'hotel Relais Torre Marabino (Ispica RG, Italia)
per averci concesso il loro spazio per il servizio fotografico.